



# U Navimow User Manual

Read the User Manual carefully before use.  
Make sure you understand all the instructions and safety warnings.







Segway Navimow is an advanced robotic mowing system that uses a virtual boundary, eliminating the need for complicated perimeter wiring. Easy to operate and manage, Navimow gives you more free time to do the things you love and an effortlessly impeccable lawn with every use.

Navimow contains a robotic mower, a charging station, and a GNSS (Global Navigation Satellite System) antenna. The robotic mower and GNSS antenna simultaneously receive positioning signals from satellites to locate the mower and the work area. The charging station charges the mower and transmits the satellite positioning signal received by the GNSS antenna to the mower to improve the positioning accuracy of the mower.

The robotic mower is powered by a lithium battery and can automatically cut grass in a defined work area. The work area can be defined by remotely controlling the mower through the Navimow app as needed. When mowing, the mower's driving path is automatically planned by the algorithm according to the shape of the work area to achieve the highest mowing efficiency. If the entire lawn cannot be completed at one time, the mower will automatically return to the charging station to charge. When the charging level reaches 85%, the mowing resumes from the position where it stopped.

3

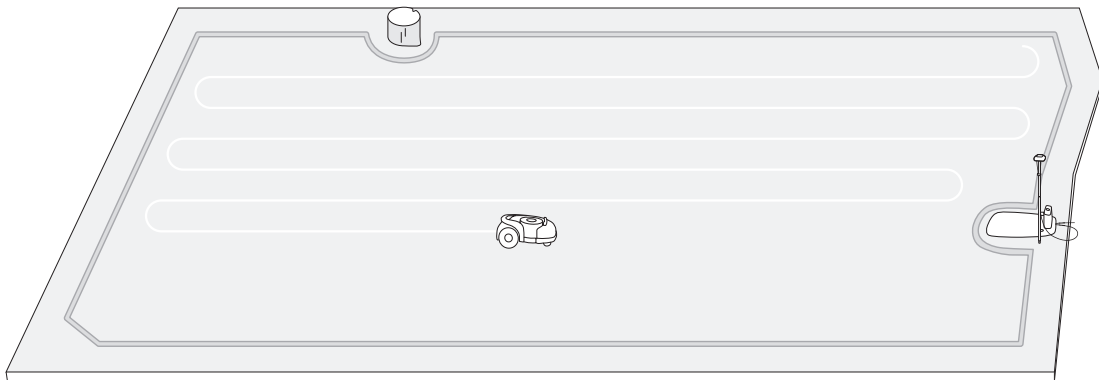

The Navimow app is an important part of the Navimow system. You can follow the interactive guidance shown via the app to complete the system installation and set up the work area. You can also use the app to adjust the settings of the mower, manage the work area, view the work status of the mower, control the mower remotely, etc. You can also get the latest and most comprehensive official Help and Support content through the app.

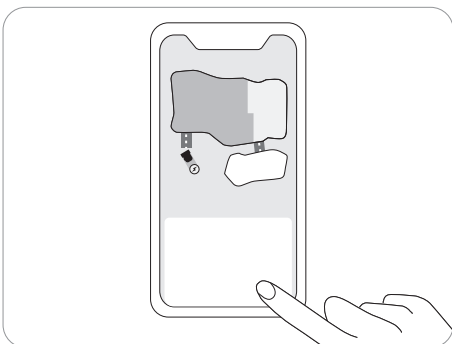

# IMPORTANT

## READ CAREFULLY BEFORE USE

### KEEP FOR FUTURE REFERENCE

- 1) Be sure to install and operate the mower and the charging station according to the instructions. Go to [navimow.segway.com](http://navimow.segway.com) for the complete User Manual and the latest user materials.
- 2) The product can be used both by consumers and for professional purposes. Using the mower for purposes other than mowing can bring serious injury. To avoid risks of injuries, please read and understand all the warnings and cautions. Please understand that you can reduce the risk by following the instructions and warnings in this manual, but you cannot eliminate all risk. The operator or user is responsible for accidents or hazards occurring to other people on their property.
- 3) Navimow has many built-in safety sensors, however, safety risks still exist. Set a mowing time when there are no people or pets on the lawn. Inform the neighbors about the risks for accidents or hazards. When using the mower on a public lawn, or when your lawn is open to your neighbor or street, protect or fence the lawn, or put up a warning sign around the working area that says: WARNING! Automatic lawn mower! Keep away from the machine! Supervise children!
- 4) DO NOT modify the mower by yourself. Modifications could interfere with mower operations, result in serious injury and/or damage, or void the Limited Warranty. Use only Segway approved parts and accessories.
- 5) The manufacturer recommends the user to be 18–70 years old. Be sure to get the necessary training before operating the machine.

#### Before Mowing:

- Regularly check that all parts of the mower can function normally.
- For the best mowing results, it is recommended to mow in dry weather. Mowing in the rain can make the grass stick on the product and the mower may slip. DO NOT mow in bad weather, such as heavy rain, thunderstorms or snow.
- Periodically inspect the area where the machine is to be used and remove all stones, sticks, wires, bones and other foreign objects. The Limited Warranty does not cover damages caused by objects left on the lawn.
- To avoid possible damage, keep the operating mower at least 1 m (3 feet) away from sprinkler heads. The mower and sprinklers should NOT work simultaneously. Time the mower so that it works at a different time from sprinklers.
- NEVER allow children to touch the power supply unit, charging station, blades, the battery compartment, or any parts with gaps such as the wheels.

#### When Mowing:

- Keep away from the rotating blades! DO NOT put hands or feet under or near the rotating blades.
- Watch out for projectile objects! Keep a safe distance from the mower when operating.
- DO NOT leave the machine to operate unattended if you know that there are pets, children or people in the vicinity.
- DO NOT overreach. Keep your balance at all times and always be sure of the footing on slopes. Walk, never run while operating the machine or its peripherals.

**Safe Usage:**

- DO NOT operate the mower outside the temperature limits: 0–50°C (32–122°F), because low/high temperatures can decrease mower performance and even lead to accidents.
- DO NOT place anything on the mower or the charging station.
- It is recommended to conduct regular maintenance of the mower (see 4. *Maintenance*) by an adult.
- Regularly check the warning devices to ensure they are effective. These devices include the buzzer, the LED light on the charging station, and the ambient light on the mower.
- Before charging, please read *How to Charge in Chapter 2.3*. Improper use may cause electric shock, overheating, or leakage of corrosive liquid.
- If the cord on the power supply or the extension cable becomes damaged or entangled during use, disconnect the power supply from the power socket and then untangle. To avoid a hazard, pull the body of the plug rather than the cord when separating the power supply from the power socket. Contact after-sales service and have a professional technician to repair or replace the cord.

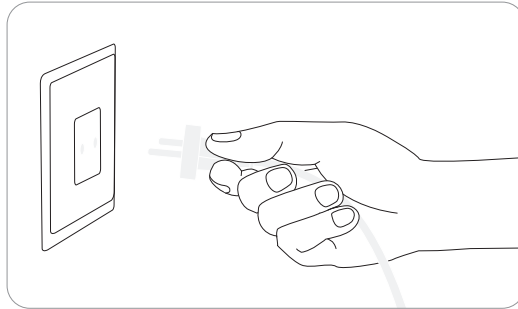

# 1.3 What's in the Box?

If there are missing or defective parts, please contact after-sales service. We recommend retaining the package for future transportation and shipping.

## • Navimow

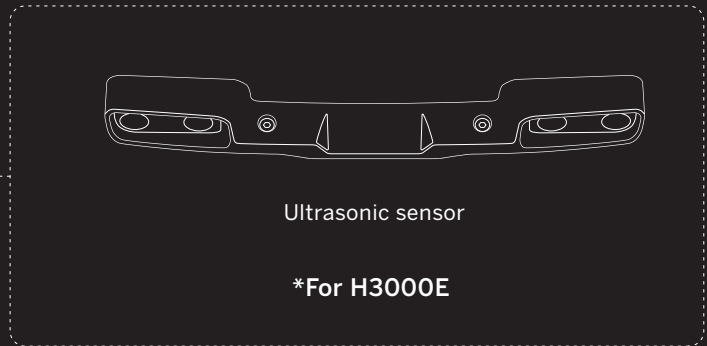
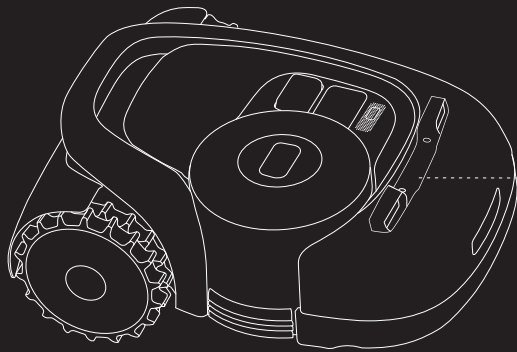

Power supply



Extension cable



Pegs to secure the extension cable × 10

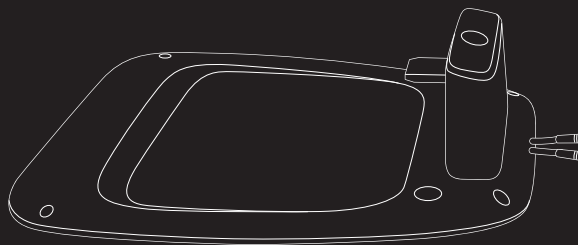

Charging station and the installation kit

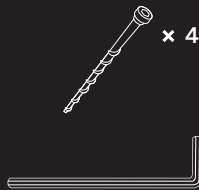

× 4

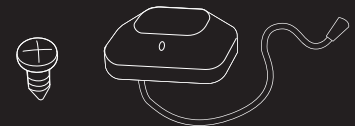

GNSS antenna kit

## ⚠ WARNING

Sharp edges. Do not point at people.

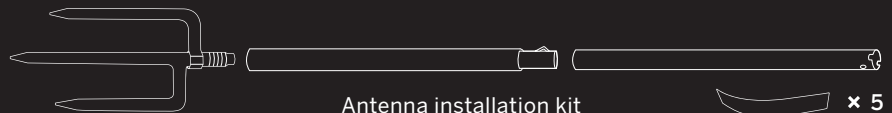

Antenna installation kit

× 5

## • User materials

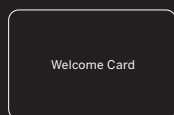

Welcome Card

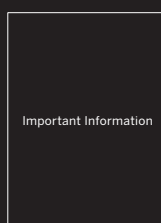

Important Information



Quick Start Guide



Spare blades and bolts

- GNSS antenna in the mower
- Lifting handle

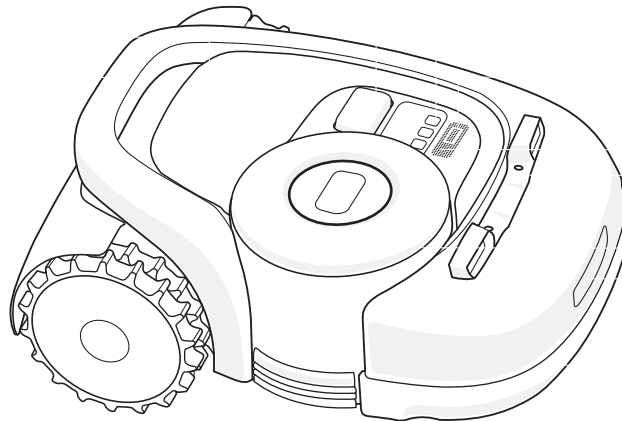

- STOP button
- Control panel
- Rain sensor
- Buzzer
- Ultrasonic sensor
- Ambient light
- Charging strip
- Bumper

- **Ambient light:** Navimow will have specific lighting effects to remind you to pay attention to the state of the mower. See 3.2 *Light Cue*.
- **Lifting handle:** Helps you to lift the mower when necessary. See 4.3 *Transportation*.
- **Stop button:** Stops the mower and the blade immediately. When the mower encounters a fault and displays a 4-digit error code, press the STOP button to clear the error code and try to fix the fault. See 5. *FAQ & Troubleshooting* for detailed guidance.
- **Control panel:** The buttons on the control panel can be used for the basic operations of the mower: switch the mower on and off, start mowing, return to the charging station, enter the PIN code to unlock the mower, etc. See 3.1 *Display and Control on the Mower*.
- **Rain sensor:** For raindrop detection. See Rain sensor in 3.6 *Settings (Mower)*.
- **Bumper:** When the bumper hits an obstacle and triggers the internal sensor, the mower will go backward and avoid the obstacle. See Bumper in 3.9 *Obstacle Avoidance*.
- **GNSS antenna in the mower:** In addition to the GNSS antenna connected to the charging station, there is also a GNSS antenna inside the mower to improve positioning accuracy. See 1.6 *How the EFLS Works*.
- **Ultrasonic sensor:** Certain models are equipped with an Ultrasonic sensor, which could detect obstacles and avoid collision. The sensor is also sold separately and can be installed on all Navimow models. Consult your dealer for details.



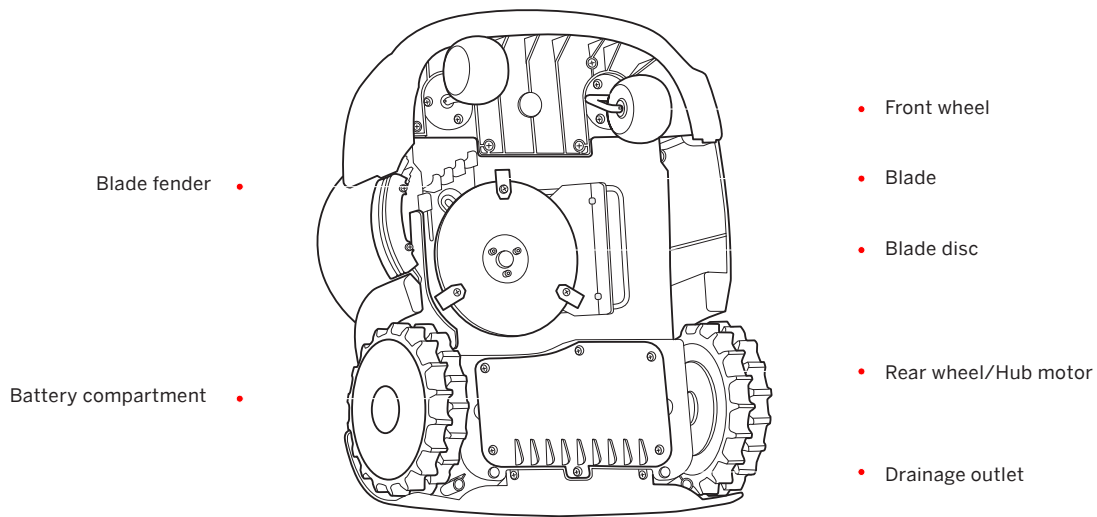

Blade fender •

Battery compartment •

- Front wheel
- Blade
- Blade disc
- Rear wheel/Hub motor
- Drainage outlet

- **Blade:** The blades can rotate freely after being attached to the blade disc. When mowing, the spinning blade disc will generate centrifugal force to keep the blades pointing outside so that the blades can cut grass. When hitting an obstacle, the blade will turn inside. See *4.2 Replace Blades* for replacement guide.
- **Blade disc:** Blade disc height adjustment through Navimow App. See *How to change the cutting height in 3.6 Settings (Mower)*.

- **GNSS antenna:** Receives satellite signals to improve the positioning accuracy of the mower. See *1.6 How the EFLS Works* for

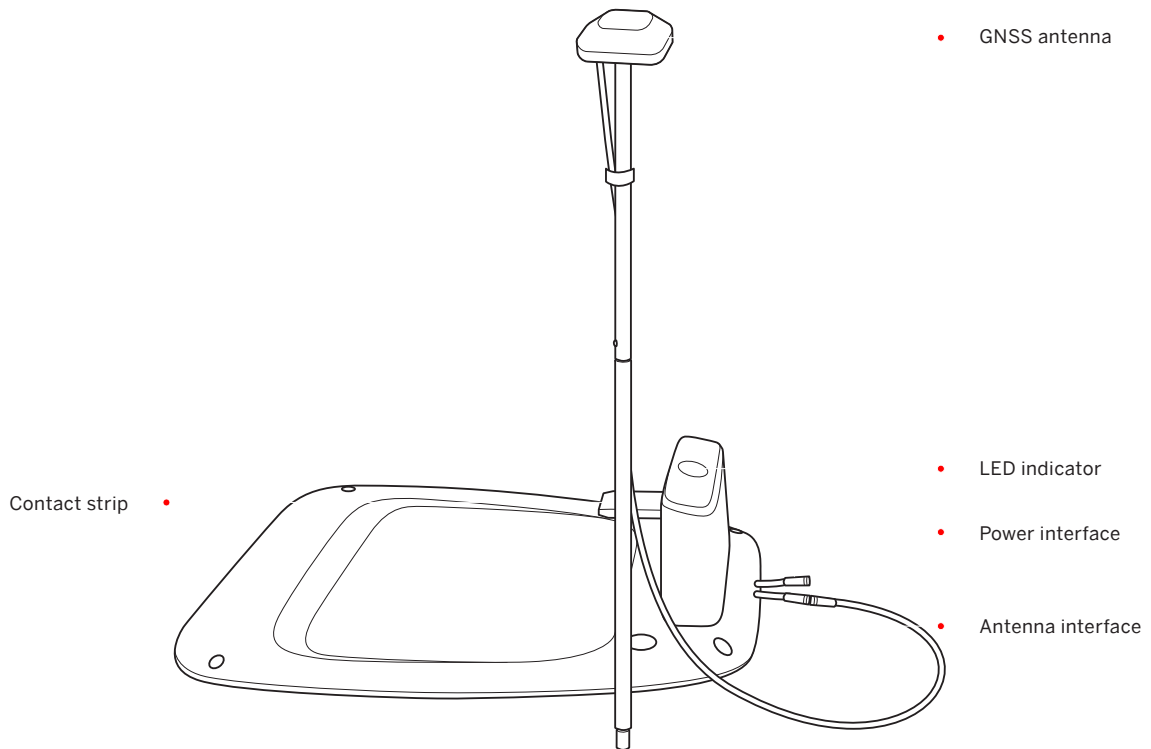

Contact strip •

- GNSS antenna
- LED indicator
- Power interface
- Antenna interface

- **LED indicator:** Indicate different working states with various colors. See *3.2 Light Cue* for details.

Please study the symbols on the product and labels carefully and understand their meaning:



9



This product conforms to the applicable EC Directives.

RoHS

This product conforms to the regulations of Restriction of Hazardous Substances.



Before charging, read the instructions.

UK  
CA

This product conforms to the applicable UK legislation.



Polarity of the charging port



Class II appliance



SMPS incorporating a short-circuit-proof safety isolating transformer (inherently or non-inherently)

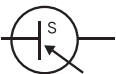

SMPS (Switch mode power supply unit)



DoE Level VI efficiency



The maximum altitude of use is 5000m

IP55/IP66

IP55/IP66

ta: 40°C

The maximum temperature of use is 40°C



Direct current



Alternating current



Class III appliance

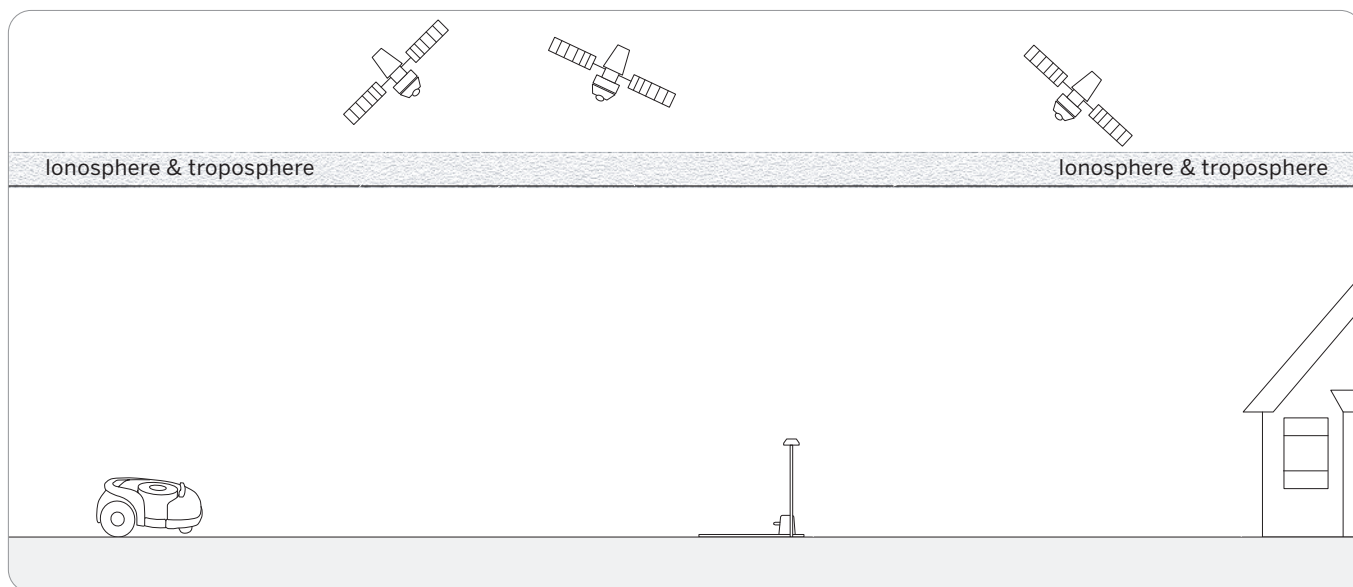

- EFLS (Exact Fusion Locating System) is Segway's unique high-precision fusion technology. Based on satellite positioning, EFLS technology integrates various sensor data to improve positioning accuracy and fault tolerance through algorithm fusion.
- The mower can locate itself through satellite signals, which can also be picked up by the antenna. By comparing the satellite signals from the antenna and the mower, errors in the transmission of the signal (such as the offset of the satellite signal as it travels through the ionosphere) can be minimized, improving satellite positioning accuracy to the centimeter level.
- In addition, the data collected by the gyroscope, accelerometer, magnetic compass, and odometer sensors can also be integrated into this system through Segway's data fusion algorithms, further improving the applicability of Navimow to various environments.
- With EFLS technology, Navimow can draw a precise work area in complex outdoor environments without laying boundary wires, and optimize the mowing path through algorithms in the work area to achieve planned mowing results and maximize the mower's work efficiency.

Multi-sensor data fusion improves the applicability of EFLS to complex environments, but serious satellite signal issues will still greatly affect the normal operation of Navimow. Below are major cases of satellite signal issues:

• **Blocking**

If there are any obstacles on or surrounding the antenna and/or the mower, the signal will be weakened or blocked.

Solution: DO NOT install the charging station and antenna under a roof, tree or anywhere that may block the signal. You can also buy the antenna extension kit and install the antenna on the roof/wall.

• **Signal Interference**

Signals from the satellite are transmitted to the antenna after being reflected by the wall, instead of directly from the sky. This is called Multipath Effect.

Solution: install the antenna far from the house to get rid of the multipath effect. It is recommended not to use the mower in a scenario with walls that have long and flat surfaces or that are made of glass or metal. The long and flat surface/glass and metal surface will interfere with the signal, hence the mower may bump into the walls. The map should not be built between two high walls, because the walls will block the signal and the mower will not be able to work in this area.

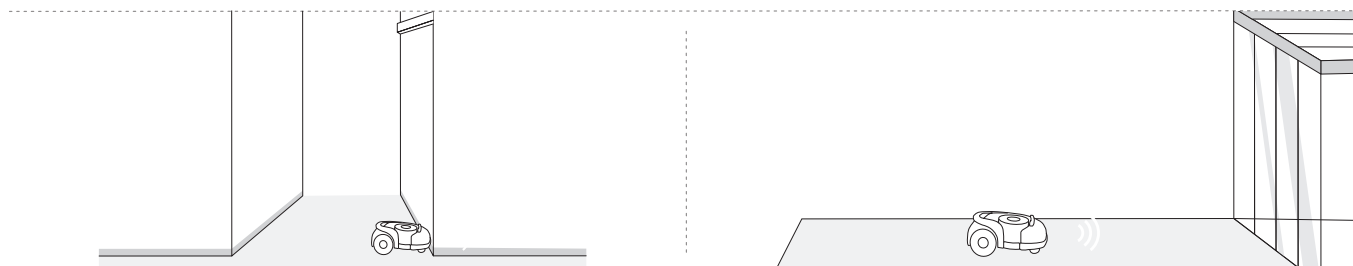

The use of Navimow relies on fine satellite positioning signals and has certain requirements for the site being used: relatively open and flat, no high-rise buildings and trees, and a large area of the sky is visible.

We created a checklist with questions on lawn shapes, houses, trees and other objects in yards. After completing the checklist, you will have a clearer understanding of whether Navimow is suitable for your yard and get a purchase suggestion. To complete the checklist, visit <https://navimow.segway.com/checklist>.

If your yard has the following features, you will need to purchase the VisionFence sensor to help Navimow handle more complex yards. For more information, visit <https://navimow.segway.com>.

- The lawn has a long and narrow area with high walls on both sides.
- There is a large area of a glass/metal wall or a wall with a long and flat surface.

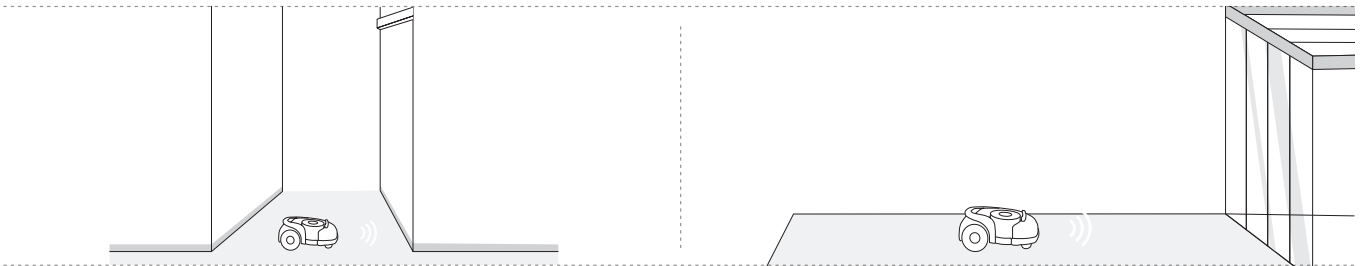

- There are tall trees (usually above 5 m) with big tree crowns.
- The density of the trees is thick.

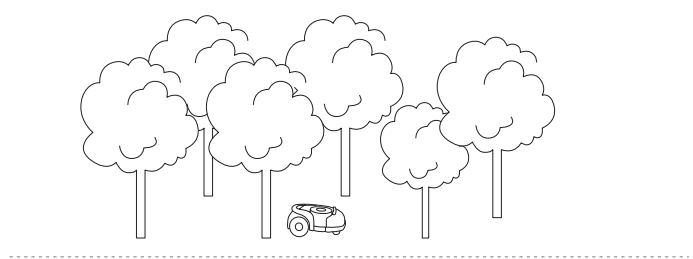
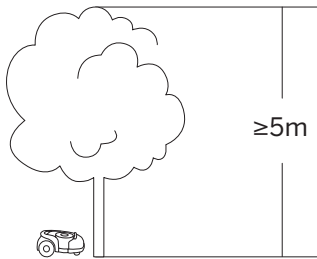

If your yard has the following features, you may need to purchase the Antenna Extension Kit, and install the antenna at a higher position to obtain better satellite signals, but the possibility of poor performance cannot be ruled out.

- The satellite signal is poor in the narrow path connecting the front yard and the back yard.

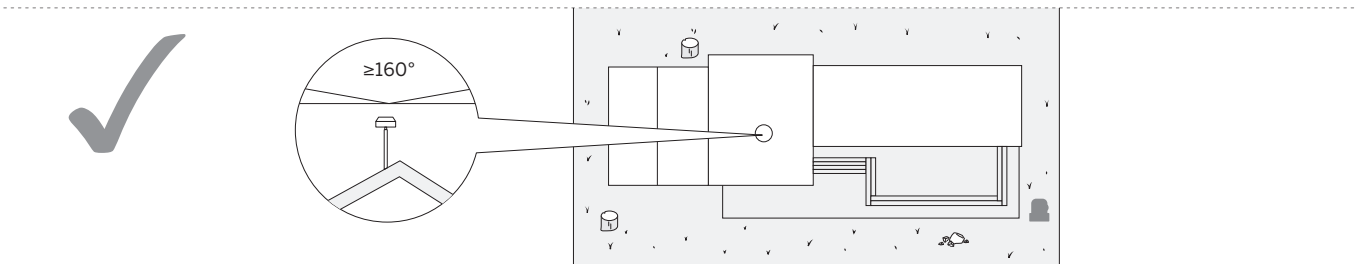

- The lawn tightly surrounds the building, and other buildings are within close proximity.

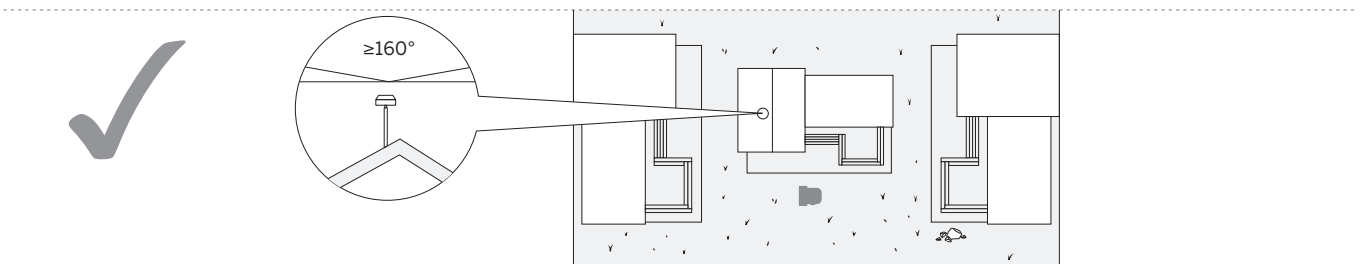



		H500E	H800E	H1500E	H3000E
Basic Information	Product Name	Navimow			
	Brand	Segway			
	Dimensions: Length x Width x Height	603 x 468 x 264 mm ( 23.7 x 18.4 x 10.4 in)			
	Net Weight (Battery Included)	16.3 kg (35.93 lbs)		16.6 kg (36.59 lbs)	16.9 kg (37.26 lbs)
	Material	Mower frame: PP; cover: ASA			
Mower Parameters	Recommended Mowing Area	500 m <sup>2</sup> (0.12 acre)	800 m <sup>2</sup> (0.20 acre)	1500 m <sup>2</sup> (0.37 acre)	3000 m <sup>2</sup> (0.74 acre)
	Typical Mowing Time Per Full Charge <sup>[1]</sup>	About 180 min		About 240 min	
	Area Capacity per Hour	100 m <sup>2</sup> (0.025 acre)			150 m <sup>2</sup> (0.04 acre)
	Cutting Width	21 cm (8.3 in)			
	Cutting Height	30–60 mm (1.2–2.4 in)			
	Charging Time	About 3 h		About 4 h	About 5 h
	GNSS Working Mode	GPS, Beidou, Galileo, GLONASS			
Noise Emissions <sup>[2]</sup>	Measured Sound Power Level LWA	54 dB(A)			
	Sound Power Uncertainties KWA	3 dB(A)			
	Sound pressure level LpA	43 dB(A)			
	Sound pressure uncertainties KpA	3 dB(A)			
Working Conditions	Working Temperature	0–50°C (32–122°F); 10–35°C (50–95°F) recommended			
	Storage Temperature	-20–50°C (-4–122°F); 10–35°C (50–95°F) recommended			
	IP Rating	Mower body IP66; charging station IP56; power supply IP55			
	Max. Incline Inside Working Area	45%			
	Max. Incline at Boundary	10%			
Minimum Angle for Cutting Area	90°				
Connectivity	Bluetooth® Frequency Range	2400.0–2483.5 MHz			
	ISM band radio connection	865-868 MHz			
	Wi-Fi/Cellular Network	Wi-Fi 2.4 GHz (2400–2483.5M)	Cellular network LTE-FDD: B1/B3/B5/B7/B8/B20/B28 LTE-TDD: B38/B40/B41	+	Wi-Fi 2.4 GHz (2400–2483.5M) <sup>[3]</sup>
Driving Motor	Rated Speed	0.4 m/s			0.6 m/s
	Motor Type	8-inch hub motor			
Blade Motor	Top Speed	2800/min			
	Motor Type	Brushless motor			
Battery Pack	Battery Type	Lithium-ion battery			
	Nominal Voltage	21.6 V DC			
	Nominal Capacity/Energy	5200 mAh /112 Wh		7800 mAh /168 Wh	10400 mAh/224 Wh
	Battery Management System	Over-heating, short circuit, over-current and over-charge protection			
Power Supply	Supply Unit Model	For the European Union: NBW32D002D5N-EU, for the United Kingdom: NBW32D002D5N - UK			
	Input Voltage	100–240 V AC			
	Output Voltage	32 V DC MAX			
	Output Current	2.5 A			

		H500E	H800E	H1500E	H3000E
<b>Charging Station</b>	<b>Input Voltage</b>	32 V DC			
	<b>Input Current</b>	2.5 A MAX			
	<b>Output Voltage</b>	25.2 V DC			
	<b>Output Current</b>	2.5 A			
	<b>Indicator</b>	LED			
<b>Other Features</b>	<b>Front Wheel</b>	Omni-directional wheel with built-in Hall sensor			
	<b>Rear Wheel</b>	Rubber tyres with hub motor			
	<b>Sensors</b>	IMU Sensor, BladeHalt Sensor, Bump Sensor, Lift Sensor, Rain Sensor, Wheel Encoder		IMU Sensor, BladeHalt Sensor, Ultrasonic sensor, Bump Sensor, Lift Sensor, Rain Sensor, Wheel Encoder	

[1] Tested at a standard cutting speed with a full battery at an ambient temperature of 25°C (77°F) while mowing a flat lawn. The product can mow more per hour on open areas than on separated small lawns. When the grass is wet or long, the working capacity is also smaller. The flatter the lawn surface, the larger the working capacity.

[2] The noise emission declarations conform to EN 50636-2-107.

[3] Wi-Fi connectivity is only available for products manufactured after week 39 2022.



To ensure a successful setup, please scan the QR code to download the Navimow app. Alternatively, go to the Google Play Store (Android) or the Apple App Store (iOS) and search "Navimow". After installing the app, please register and log in.

Remove debris, piles of leaves, toys, wires, stones and other obstacles. Make sure children and pets are off the lawn. Please cut your lawn to a height of no more than 6 cm.

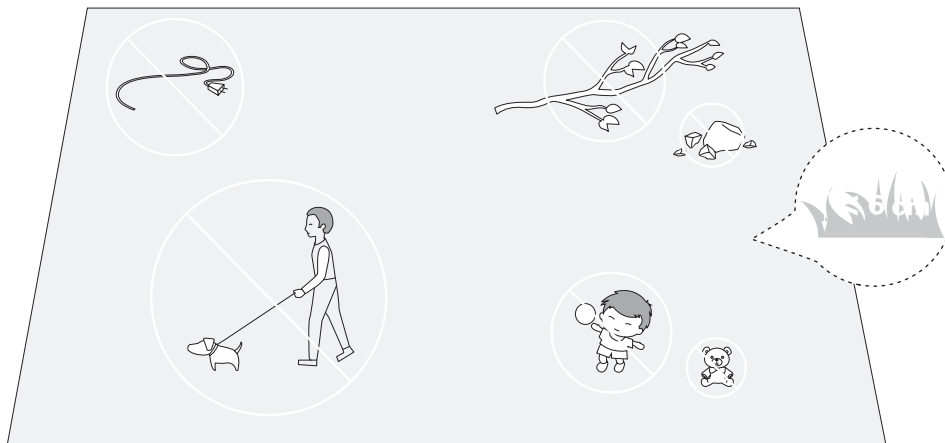



Install the charging station on a soft and flat surface.

When placed outside, the charging station and the lawn should be kept at the same level.

In order to ensure that the antenna can receive good satellite signals, please choose a suitable location to install the charging station and antenna:

1. Remain a certain distance away (greater than 2 m) from houses, trees and walls.
2. Install the charging station and antenna in an open space with nothing blocking the signal (for example, the tree canopy or the sunshade umbrella), where the antenna has a clear sky view that at least  $110^\circ$  of the sky is unobstructed.
3. Please place the charging station on a flat non-hardened ground with the antenna upright. Do not install the antenna at an angle.
4. To ensure smooth docking, leave a minimum of 10 cm at the back of the charging station and 1 m at the front.
5. Stay away from sprinkler heads, fountains or other outdoor water systems.
6. Stay away from substations, generators, water pump stations and air conditioners.

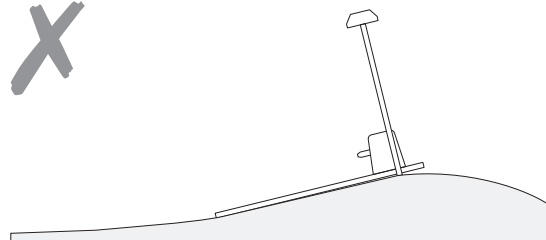
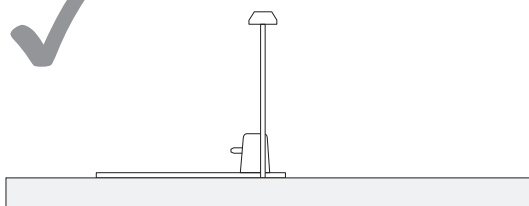
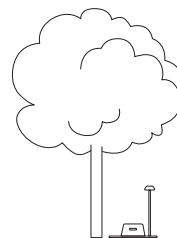
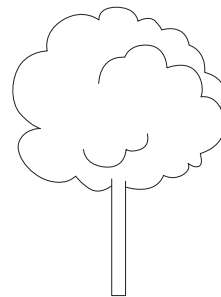
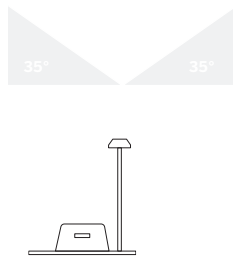

If you can't find a suitable location on the ground, consider using the Antenna Extension Kit (sold separately) to mount the antenna on a roof or wall for a better satellite signal. See Antenna Extension Kit in 3.10 Accessories (optional) for more information.

1. When installing the Antenna Extension Kit, please ensure that the antenna stays upward, and is not blocked by leaves, chimneys and other facilities, so that the antenna has a clearance range greater than 110°.

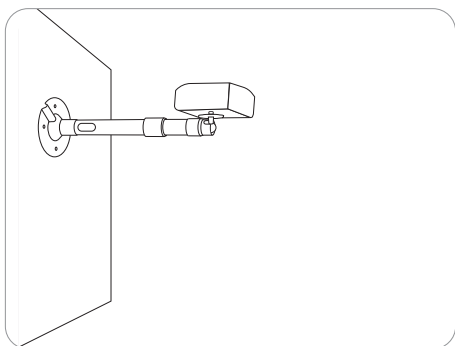

2. When using the Extension Kit to install the antenna at a high place, it is also necessary to ensure that the charging station is not too close to tall walls and trees on the ground.

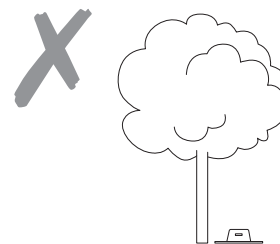
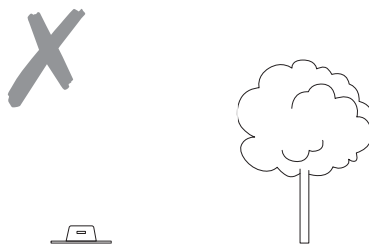
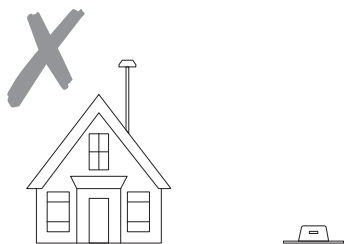
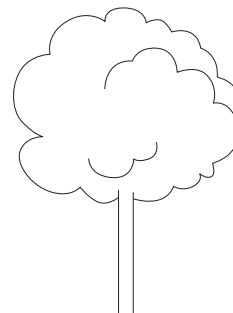
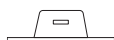

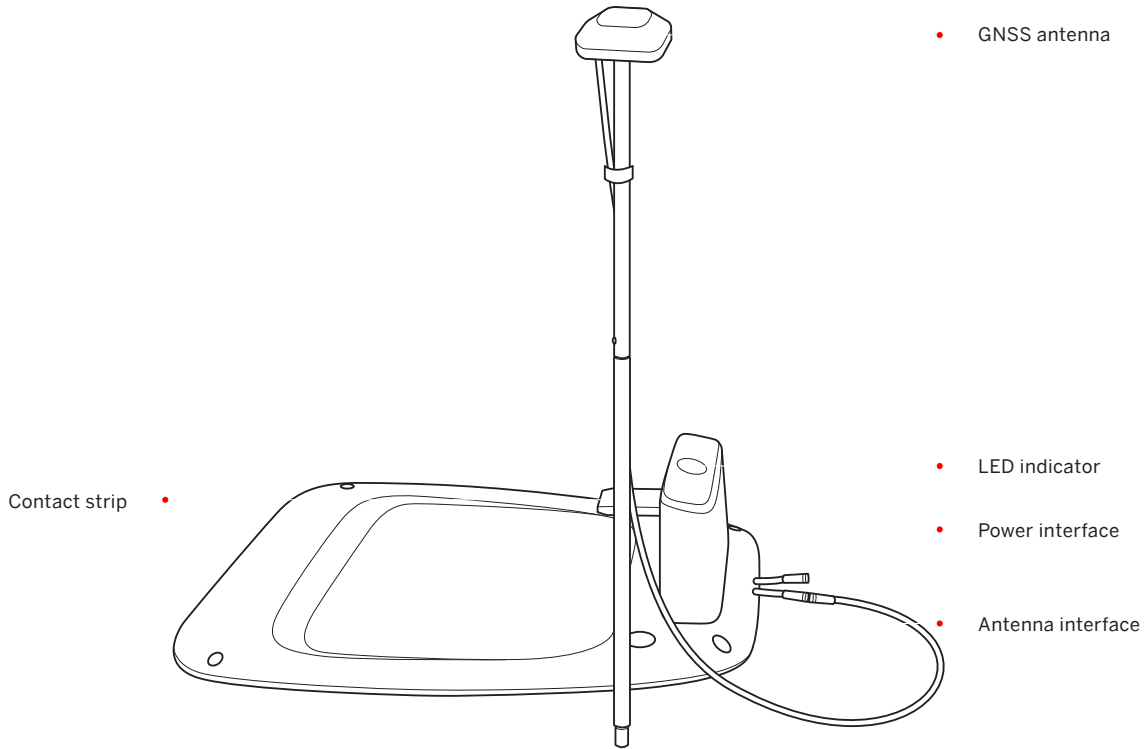

**Fix the GNSS antenna on the tube.**

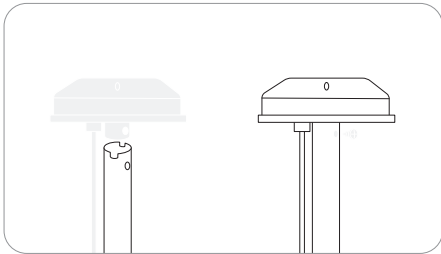

**Unfold the base fork and insert it into the ground.**

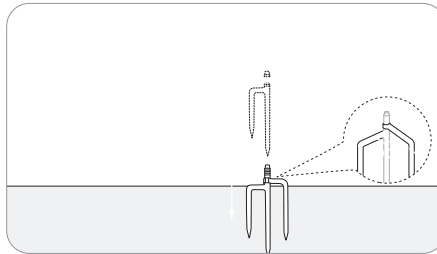

**Rotate the other extension tube onto the base fork.**

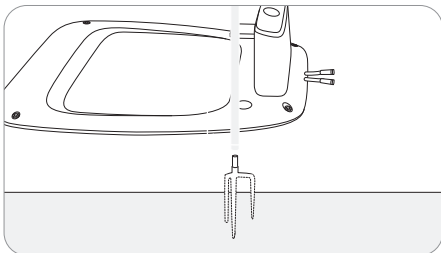

**Slide in the tube with the antenna.**

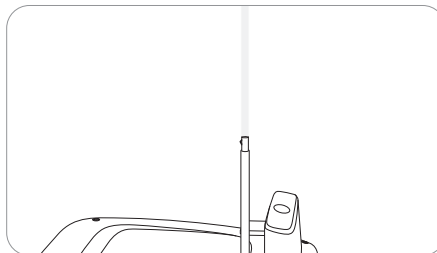

**Connect the GNSS antenna to the charging station.**

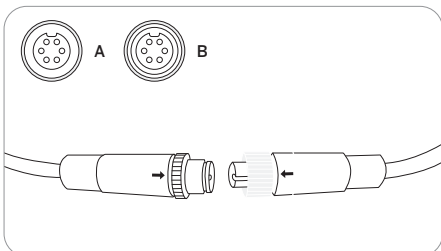

**Secure the cable on the pole with the supplied hook and loop tape.**

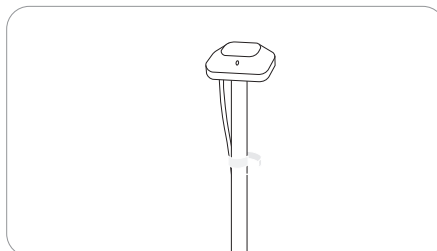

Connect the extension cable with the power supply.

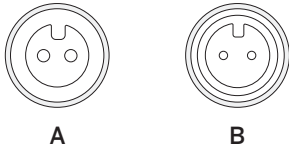

- Align the notch on the extension cable (A) with the groove on the power supply connector (B).

Connect the extension cable and the power interface.

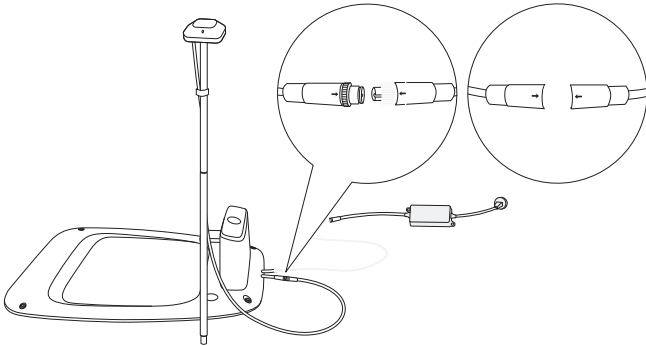

Check the signal.

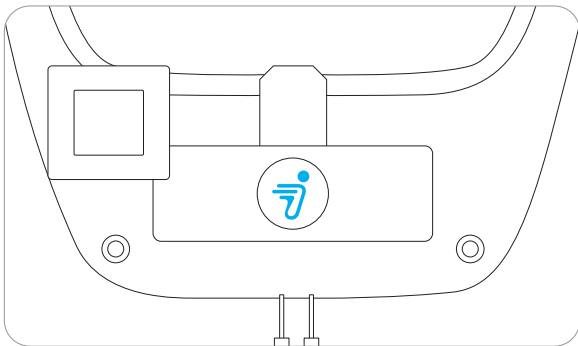

Solid blue:

- Satellite signal is strong.

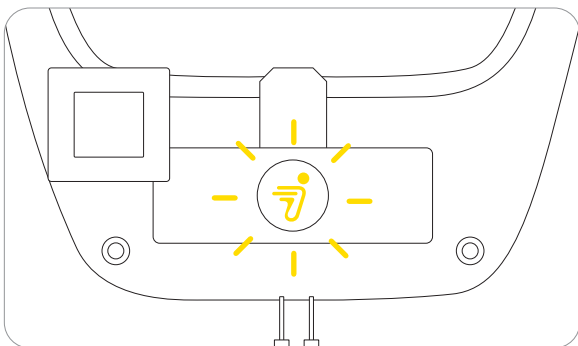

Flashing yellow:

- Poor signal, please relocate the charging station to an open space (see Step 1).
- The GNSS antenna is not connected to the charging station (see ⑤ in Step 2).

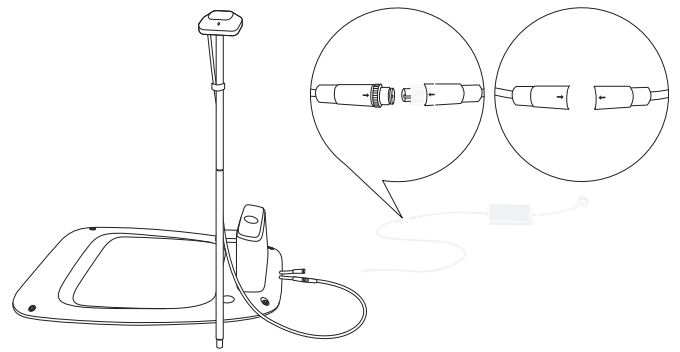

- Turn the nuts until they are locked into each other.

Insert the power plug into a suitable power socket.

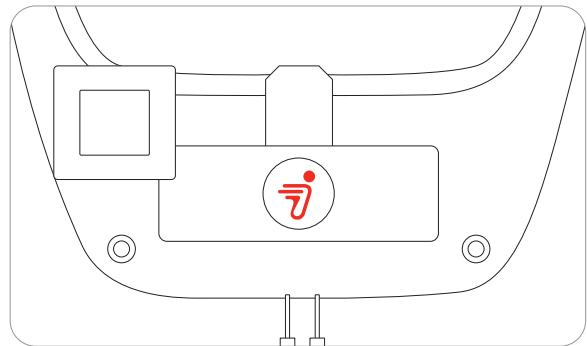
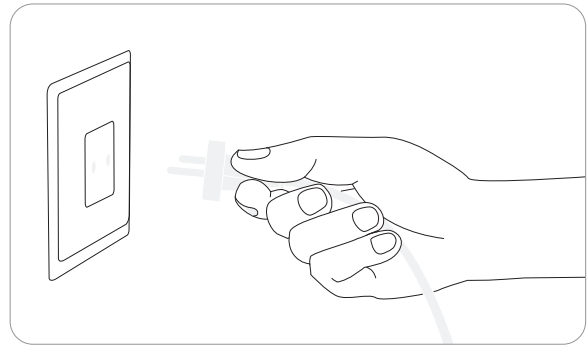

Solid red:

- No connection between the charging station and the mower.
- The mower might be powered off.

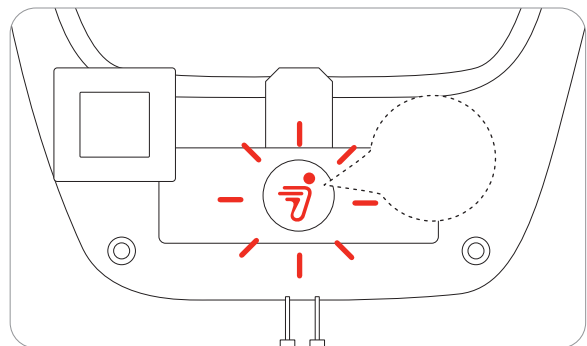

Flashing red:

- Malfunction. Please contact after-sales service.

**How to charge for the first time:**

A new mower may have a low battery after long storage. Fully charge the mower before the first use.

Place the mower in the charging station. Make sure the charging strip on the mower and the contact strip on the charging station are in good contact.

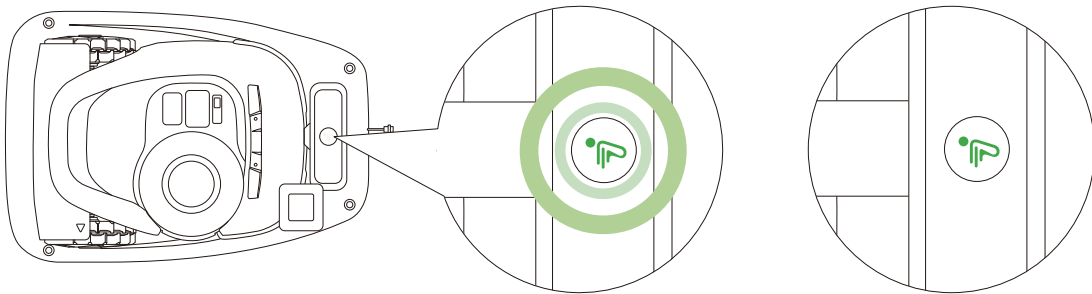
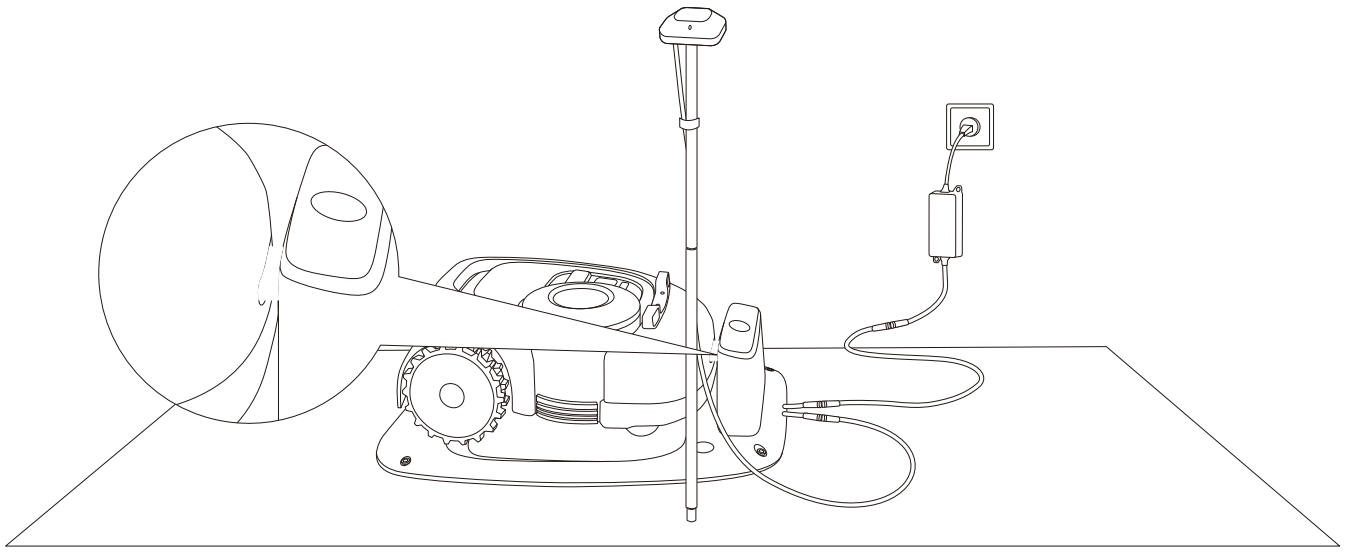

**Charging:** pulsating green

**Fully charged:** solid green

**Automatic charging:**

After setting up the virtual boundary, the mower will return to the charging station automatically when the mowing task is completed, or when the battery is low (<10%). During the mowing session, you can press the HOME and then OK button to command the mower to go back to the charging station.

**Where to place the power supply:**

- Protection from direct sunlight and rain
- Indoors with good ventilation
- Keep it at least 30 cm (12 in) above the floor to avoid possible damages caused by water.

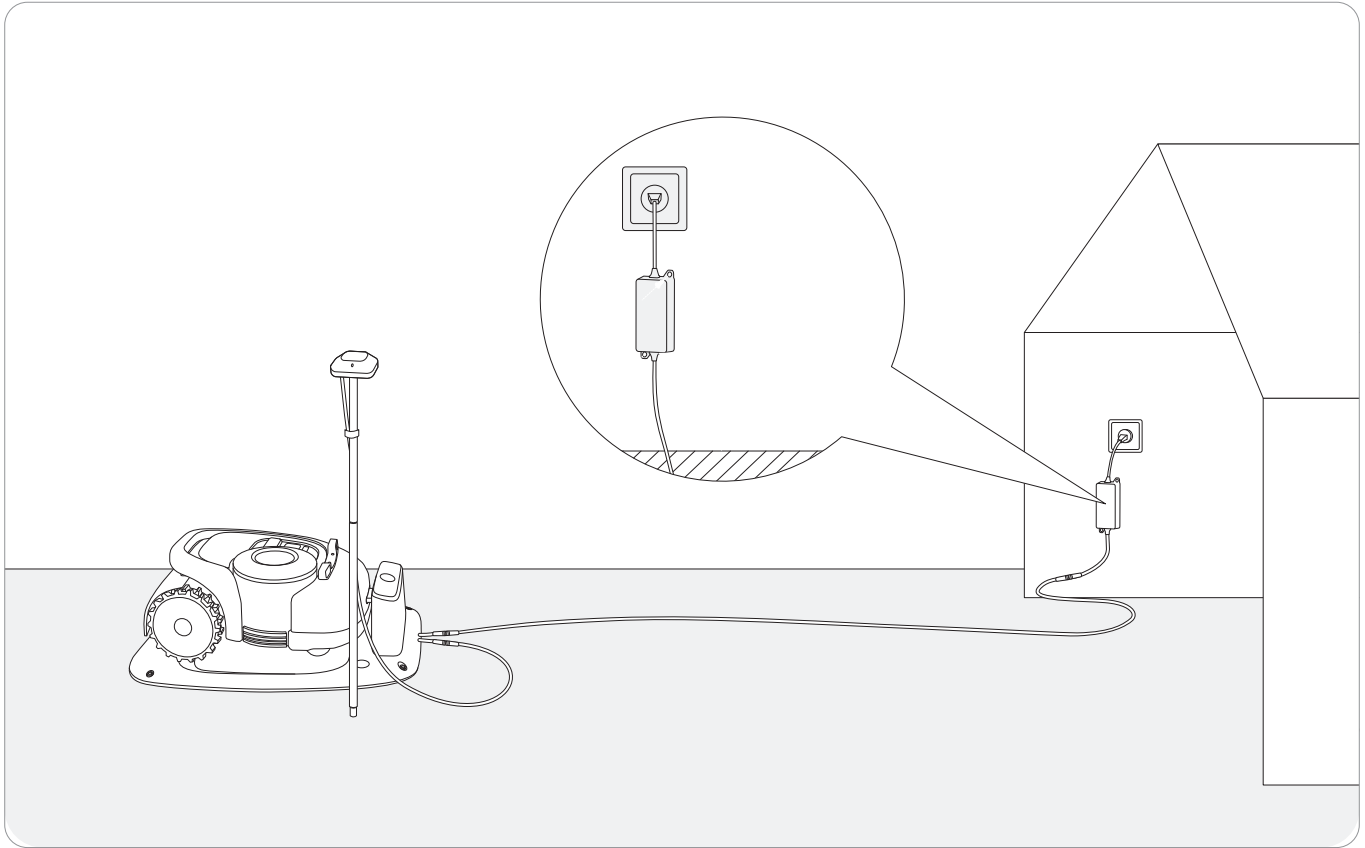

Connect the charging station to the power supply. Make sure the mower is in the charging station.

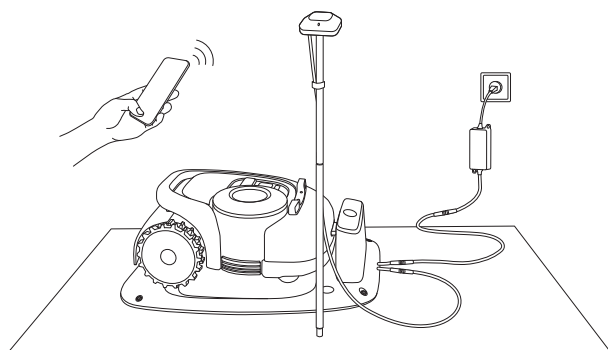

Enable Bluetooth on your phone, log in to the app and follow the instructions to pair with the mower.

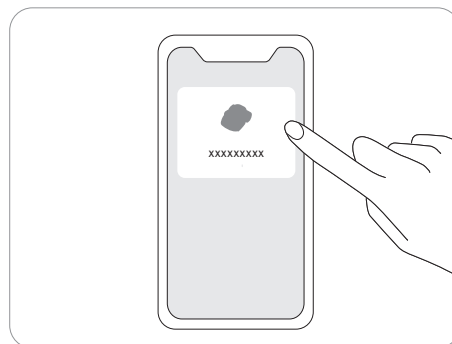

Wait patiently for 3 min until the ambient light turns green (or blue).

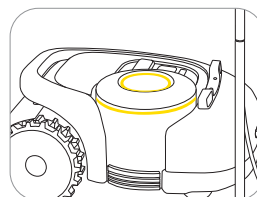
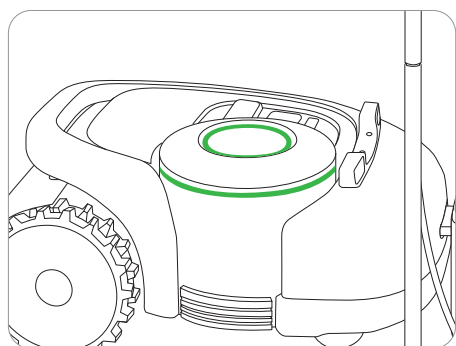

Secure the charging station with the nails supplied and secure the extension cable.

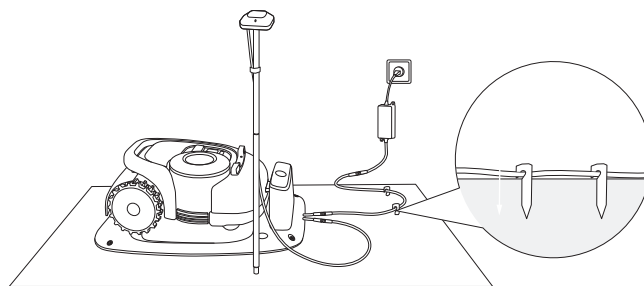
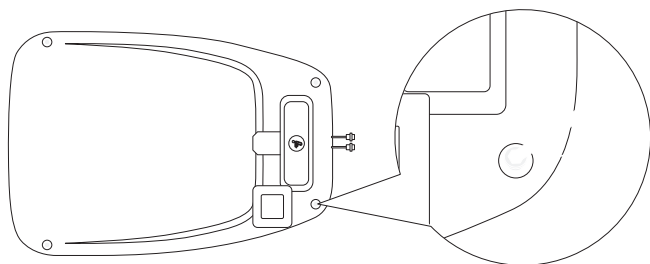

To fully experience Navimow, prior to use, please upgrade to the latest firmware.

How to update:

After activating the device, maintain the network connection state, follow the guidance in the pop-up window, and wait for 10-15 min to automatically complete the device update. During this process, please do not power off or perform other operations. You can start using it after the app prompts that the update is successful.

Follow the instructions in the app and control the mower to create the work area (referred to as the map in the manual). The mower will intelligently decide its moving pattern within the map.

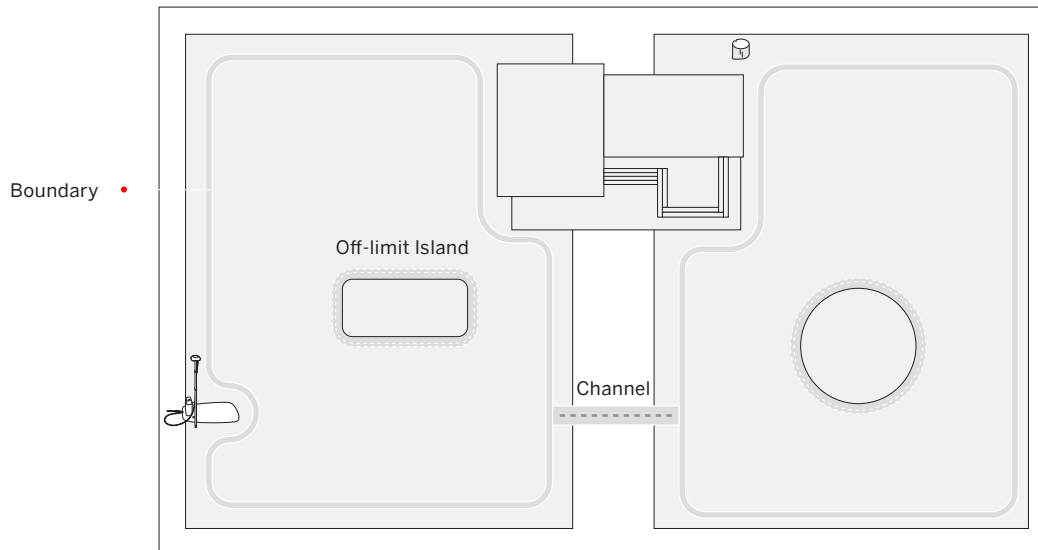

- The work area consists of Boundary, Off-limit Island and Channel.
- Boundaries delineate one single complete work area, Off-limit Islands delineate areas where the mower is prohibited, and Channels are used to connect multiple work areas.
- Inside the Channel, the mower will just pass through without cutting the grass.
- The charging station and the GNSS antenna can be installed inside or outside the work area. If the charging station is outside the work area, a channel towards the nearest boundary will be automatically set once the map is completed. The mower will return to the charging station using this channel. This channel cannot be edited or deleted.



Make sure the mower is powered on. With Bluetooth connection, your phone will connect to the mower automatically.

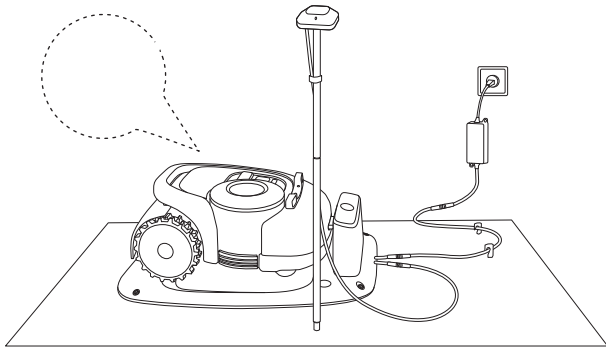

Tap "Create a map" to start mapping.



Calibrate the mower to ensure accurate positioning.

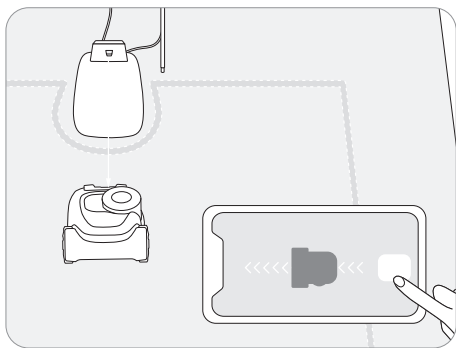

Find a proper starting point along the edge of your lawn (15 cm between the mower's right side and the edge). Keep within 6 m from the mower during the mapping process.

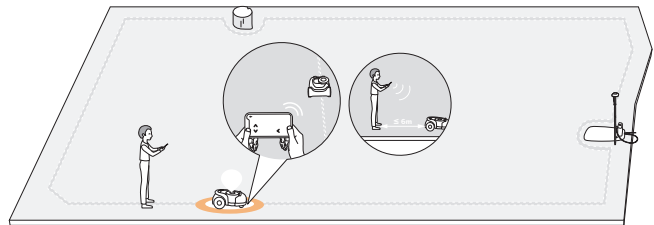

Walk along the edge.

- Distance from the edge: always keep 15 cm.

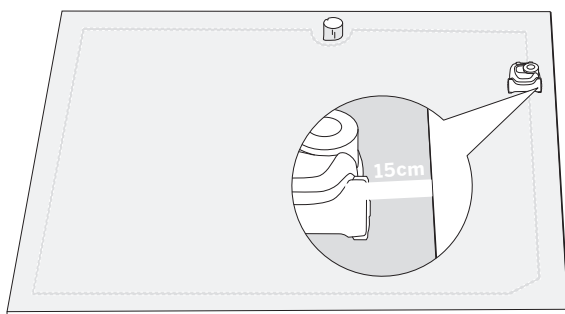

- Angle: Make sure to follow a straight line with a smooth turning angle of no smaller than 90°.

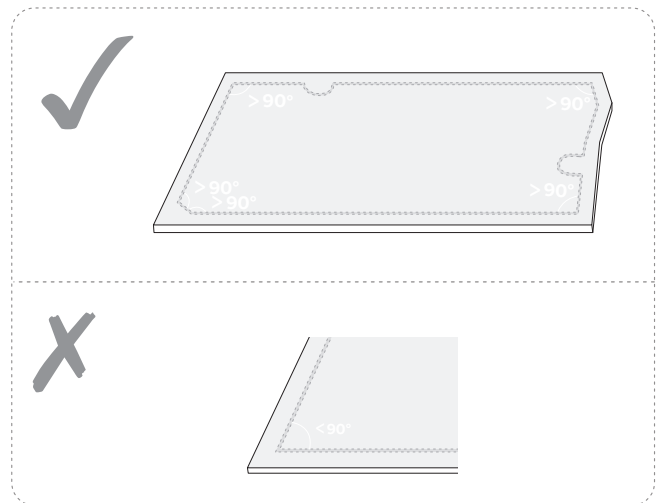

- **Direction:** Make sure the mower's right side (when moving forward) faces the boundary, so that the mower can cut as close to the boundary as possible.
- **Slope:** Even though the mower can traverse slopes up to 45% within the lawn, make sure the slope along the edge does not exceed 10%.

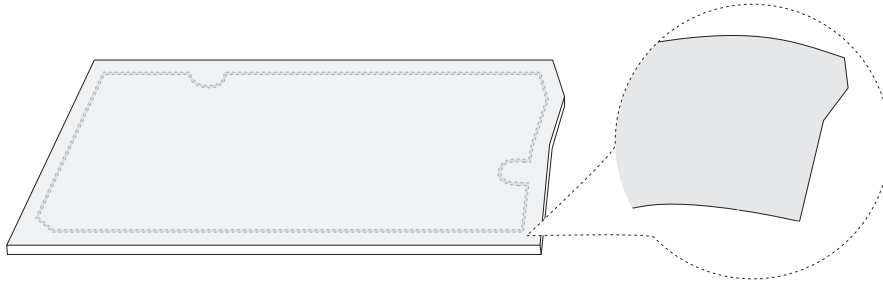

Go back to the starting point to finish the boundary mapping.

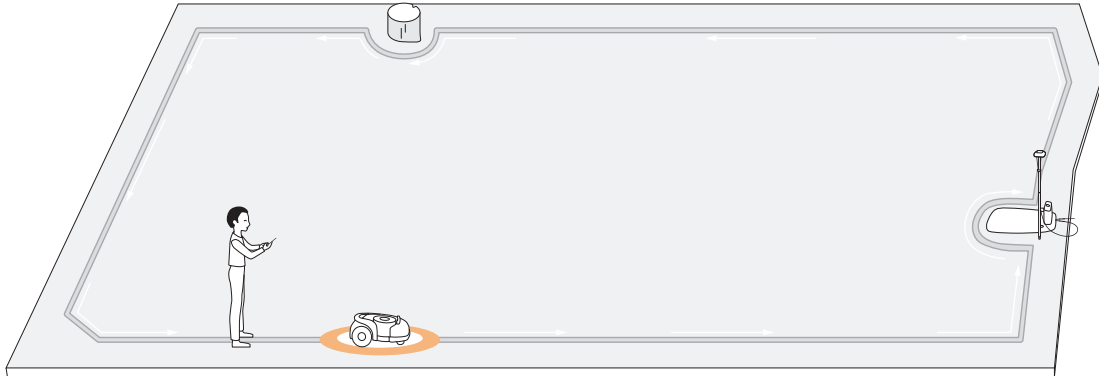

## 25

When the mower hits a hard obstacle taller than 10 cm (such as big rocks or a tree trunk), it will reverse and change the direction automatically. However, you need to lay borders for objects that need protection or areas you don't want the mower to enter, e.g., a flowerbed, small trees, lawn decorations, pond, sprinkler heads, emerged roots, etc. If you recently installed a trampoline or grill on the lawn, you can also set an off-limit island to protect it.

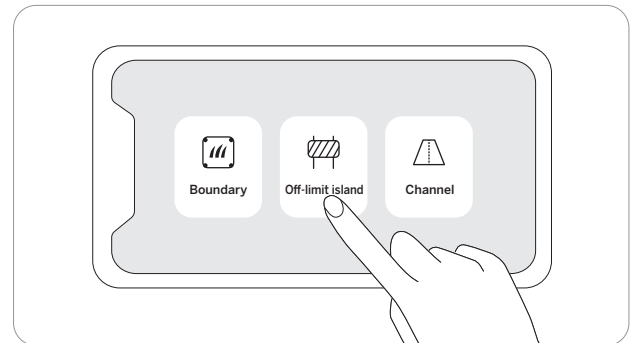

**How:** Follow the instructions in the app. When you need to cancel the area (like when you remove the trampoline from the lawn), just delete it via the app. See [How to edit the map in 3.6 Settings \(Mower\)](#).

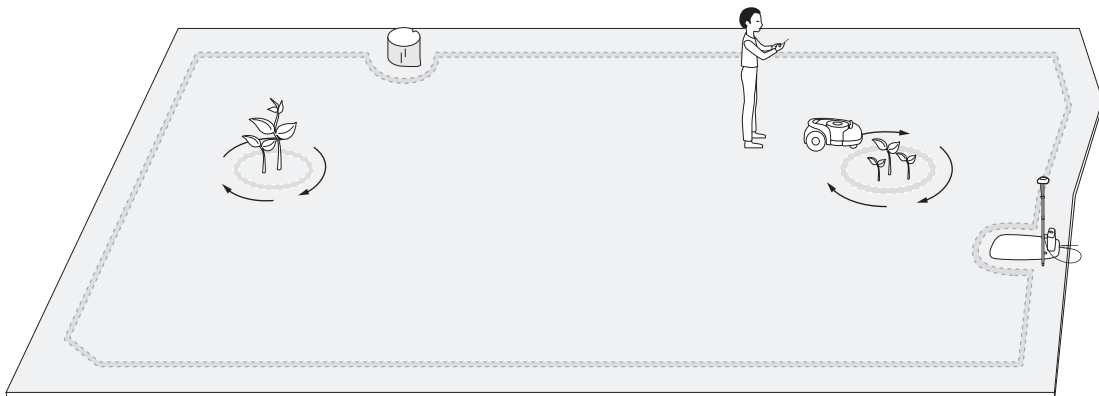

Following the instructions in the app, create a channel between separate boundaries.

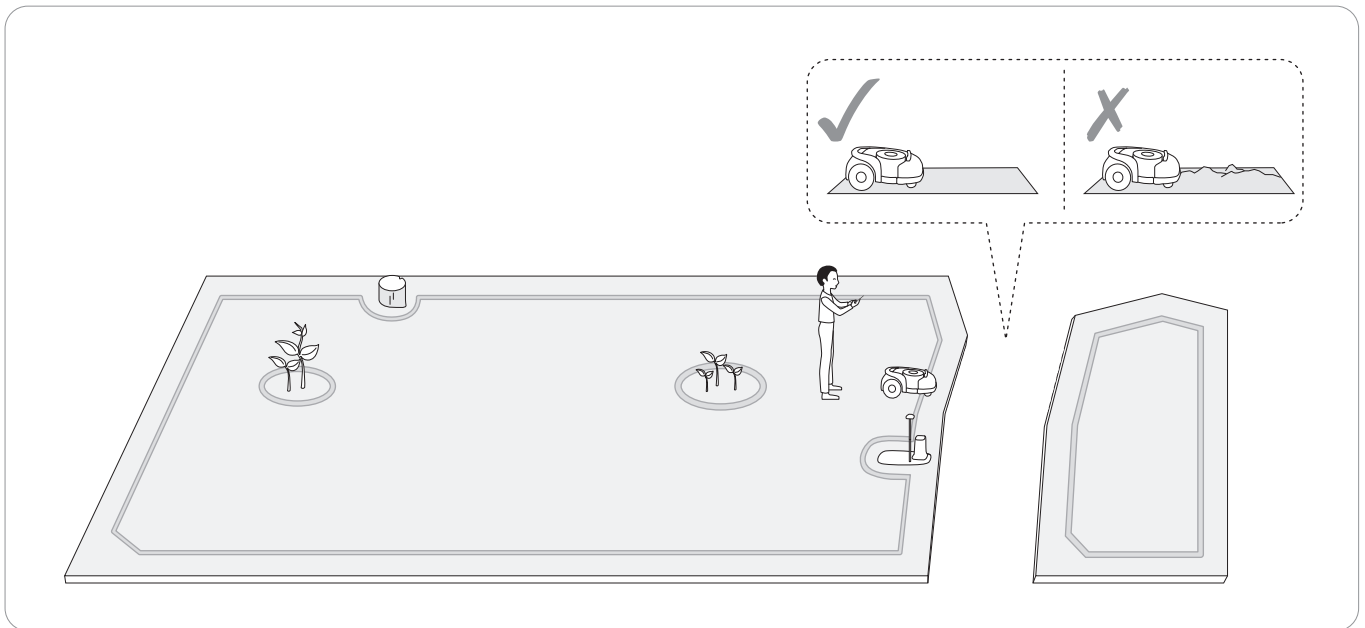
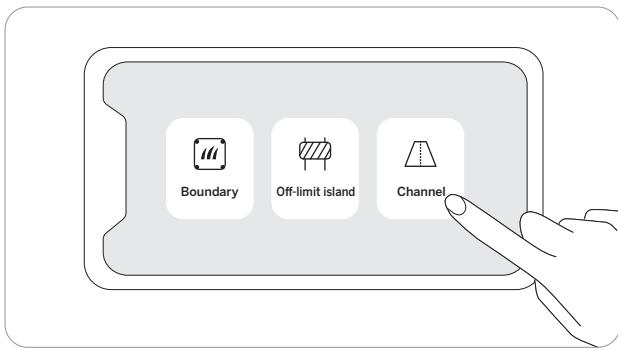

You can always adjust parts of the map in the Navimow app instead of re-creating it. Just go to Settings>MOWER>Map management>Edit, tap a boundary or off-limit island, and then tap the edit icon.

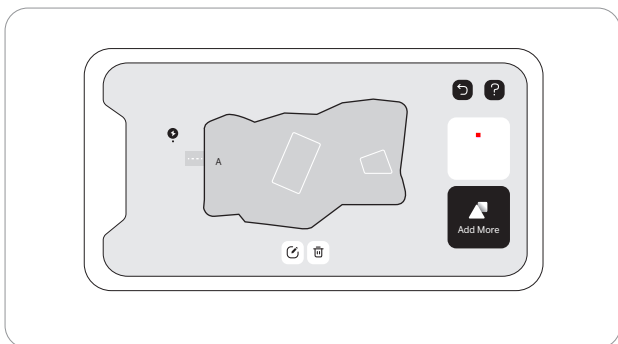

After saving the map, tap 'TEST' in the app to see if the mower works within the map. The mower will navigate along the boundary, off-limit island, and channel to test the map. After completing the test, the mower should be able to drive into the charging station and exit on its own. During the test, you need to observe whether the walking path is consistent with the mapping.

If you are adjusting the map or have a VisionFence Sensor installed, This test drive can be skipped.

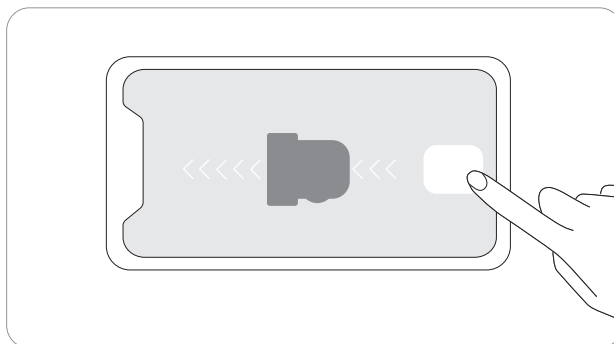

If the mower goes beyond the boundary, make sure the satellite signal is strong at the problematic spot. The mower and the GNSS antenna need to see satellites to have accurate positioning. You can try to relocate the charging station, set the map again, and then test one more time. Get help from professional technicians when necessary. Contact your nearest dealer to solve problems. You can also send an email to our after-sales service. Email: [support-navimow@rlm.segway.com](mailto:support-navimow@rlm.segway.com)

The display shows various states of the mower, and the control buttons can be used for the basic operations: power the machine on and off, start mowing, return to the charging station, enter the PIN code to unlock the machine, emergency stop, etc.



- STOP button

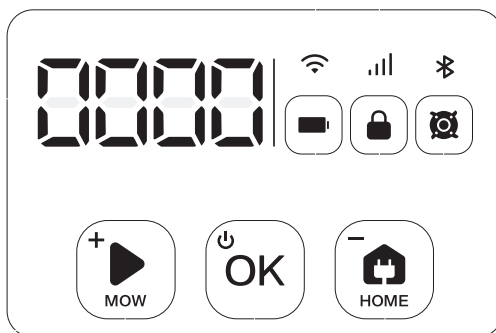

- Wi-Fi
- Cellular data
- Bluetooth

Dashboard display •

- Blade indicator
- PIN code lock status
- Battery level

- MOW
- OK
- HOME

<b>Battery level</b>	The color indicates the battery level: 50%–100% solid green, 20%–49% solid yellow, 5%–19% solid red, ≤5% red flashing. When the battery level is below 10%, the mower will return to the station and charge.
<b>PIN code lock status</b>	Mower locked. Please enter the PIN code to unlock
<b>Blade indicator</b>	Blade disc is rotating. Please do not approach
<b>Wi-Fi</b>	WiFi connected
<b>Cellular data</b>	4G connected (for H800E, H1500E and H3000E models)
<b>Bluetooth</b>	Bluetooth connected
<b>Dashboard display</b>	It shows the mowing percentage, PIN code, error code, etc. Meanings of the numbers and symbols on the display : <ul style="list-style-type: none"> <li>• ----: no map.</li> <li>• 0~100: Mowing progress will be displayed as 0~100 in percentage, for example, 70 indicates that 70% of the map is already mowed.</li> <li>• Four-digit number: error code, for example, 4011. See 5. FAQ &amp; Troubleshooting for further instruction.</li> <li>• STOP: the STOP button is pressed during mowing.</li> <li>• OtA: Updating firmware.</li> </ul>



Navimow will have specific light effects, reminding you to pay attention to the state of the mower.

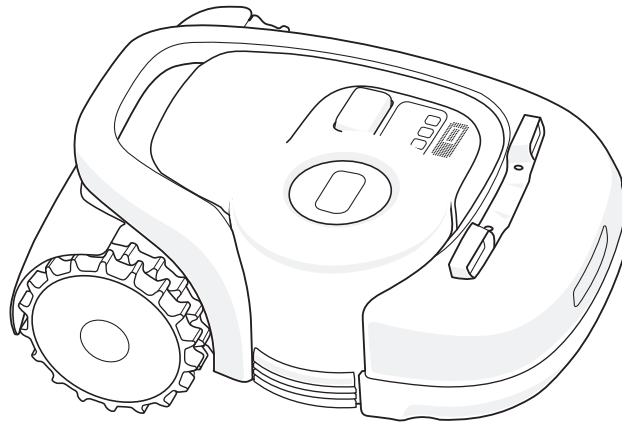

**Ambient light color and meaning:**

<b>Pulsating blue</b>	Mowing.
<b>Flashing blue</b>	The satellite signal is weak but still works fine.
<b>Solid blue</b>	Normal working status.
<b>Solid green</b>	Mower is in the charging station.
<b>Flashing yellow</b>	Poor satellite signal.
<b>Solid red</b>	Emergency stop/lifted up/no connection between the charging station and the mower.
<b>Flashing red</b>	Under error status.
<b>Flashing white</b>	OTA/Blade starts to work.

When Navimow works at night, you can turn on the dark mode to reduce the brightness of the ambient light. Go to Settings > MOWER > Light setting to turn on the dark mode. Then, customize your active time.

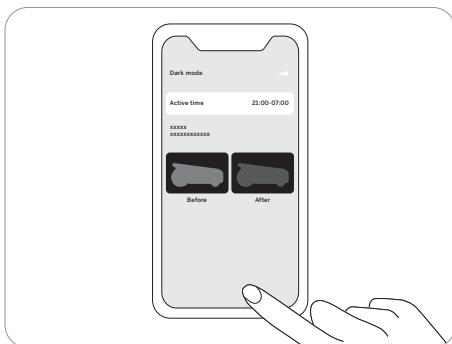

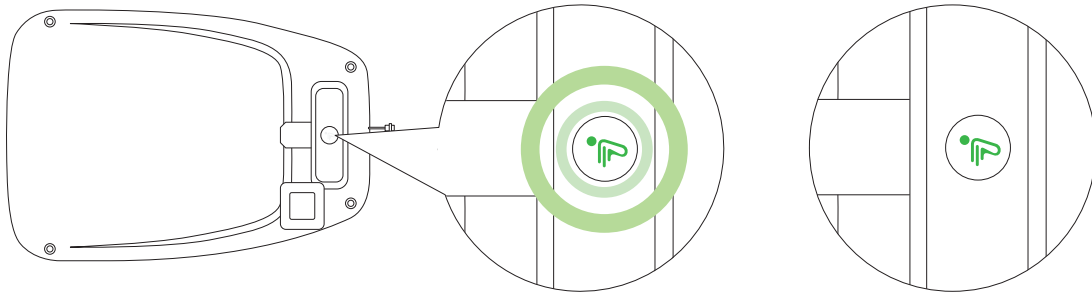

### Charging station LED indicator color and meaning

<b>Solid blue</b>	Strong satellite signal, the mower is not in the charging station.
<b>Solid green</b>	Mower is in the charging station and fully charged.
<b>Pulsating green</b>	Mower is charging.
<b>Solid yellow</b>	Poor satellite signal, the mower is not in the charging station.
<b>Flashing yellow</b>	No signal from GNSS antenna/ GNSS antenna is not connected.
<b>Pulsating yellow</b>	Antenna connected, no GNSS data.
<b>Solid red</b>	No connection between the charging station and the mower./ The mower might be powered off.
<b>Flashing red</b>	Under error status.



This part is mainly about how the mower works, how to start and pause it during daily work, etc. Work settings related to mowing, such as: scheduled mowing, how to change cutting height, map management, etc., see **3.6 Settings (Mower)**.

### Edge cut

Before mowing the work area, the mower will cut along the boundary.

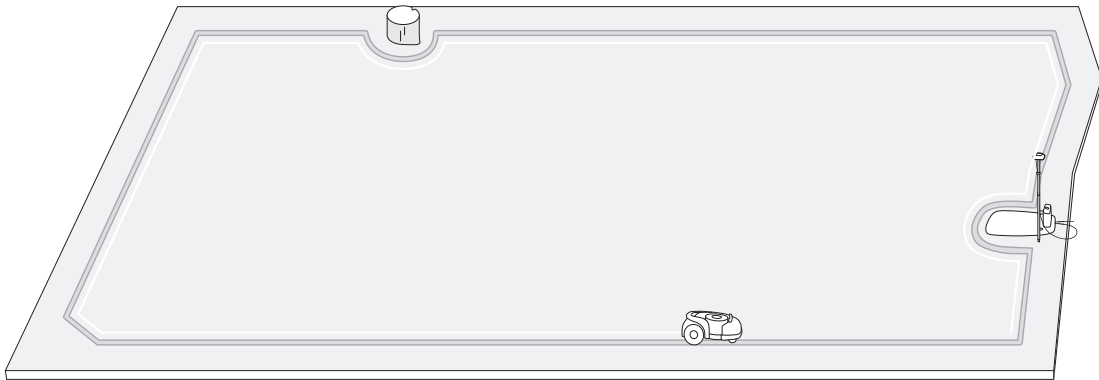

### Planned cut

Unlike most robotic lawnmowers, inside the work area, the lawnmower will mow the lawn along a planned path by an algorithm for maximum efficiency.

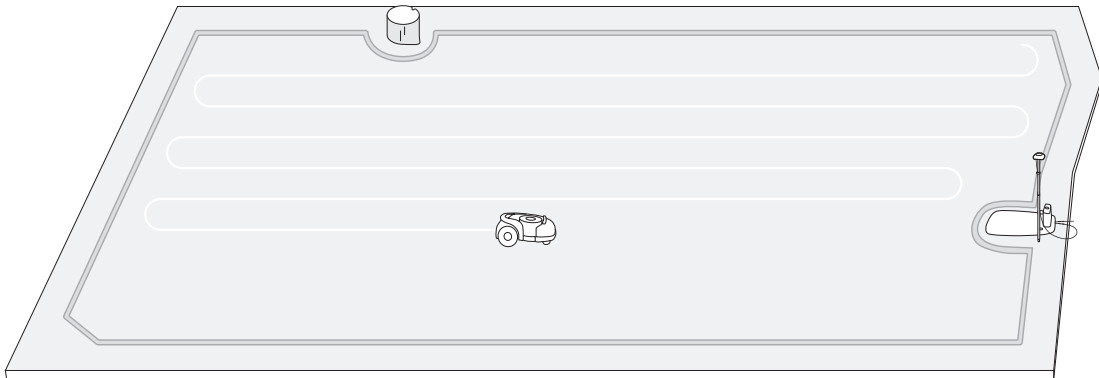

For optimal mowing results, the mowing path pattern rotates at certain angle for each new mowing task. Therefore, Navimow will not leave indentations on the lawn.

### Start Mowing

NOTE: If the mower is in lock status, first enter the PIN code to unlock the mower (see *How to enter PIN code* in 3.1). There are three ways to start mowing:

- a. In the app, tap Mow Now.
- b. On the mower, press MOW and then OK to start mowing.

- c. The mower starts automatically according to the mowing schedule. See How to set mowing schedule in 3.6 Settings (Mower) for details.

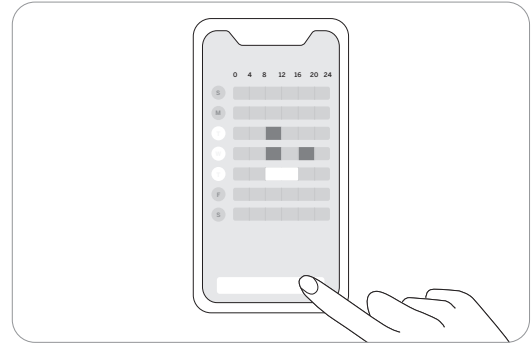
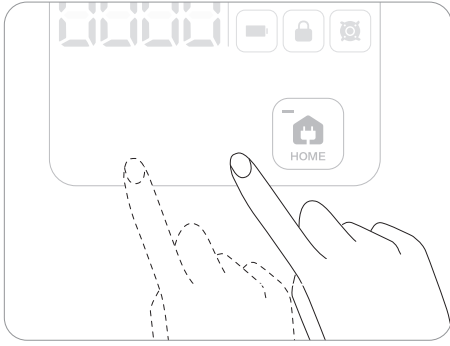

**Pause**

Press the STOP button on the mower or in the app to pause mower operation at any time.

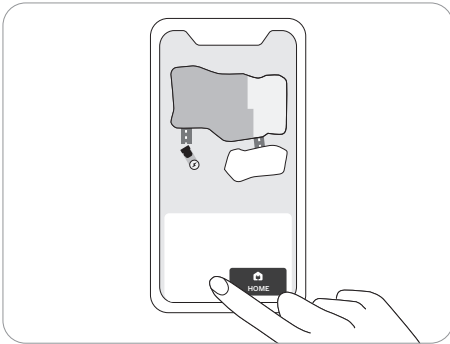

**Resume Mowing**

Continue mowing by tapping the MOW button in the app or by pressing the MOW and then OK button on the control panel.

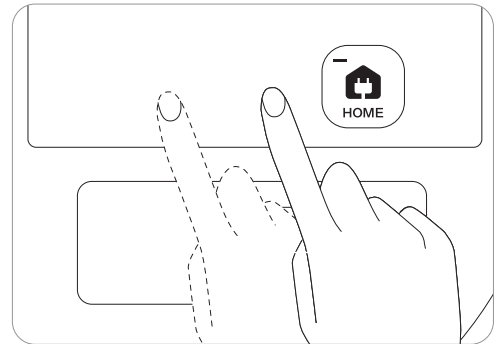
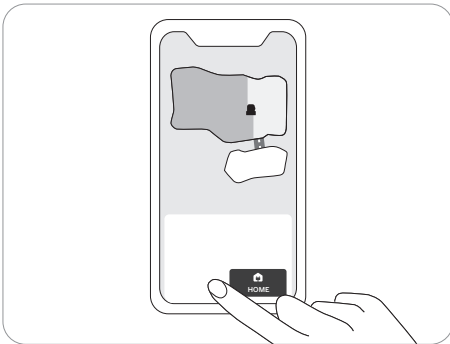

**Return to the Charging Station**

Send the mower back to the charging station in the app or press HOME and then OK button on the mower.

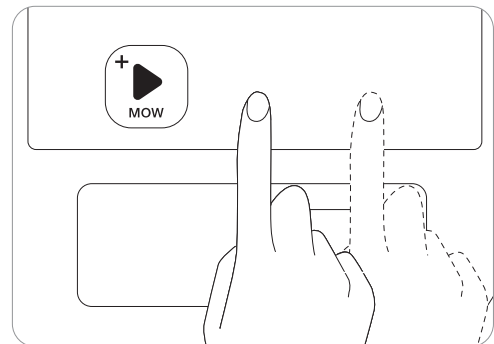
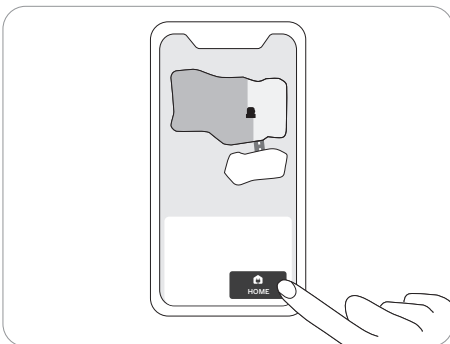

**The Navimow app is an important part of Navimow, you can use the app to:**

1. Bind and activate the mower
2. Create a map (work area)
3. Check the status and work progress of the mower, remotely control the mower to start, stop or return to the charging station, etc.
4. View and change mower work settings (Mowing schedule, Cutting height, Map management)
5. View and change mower security/function settings (PIN, ambient light, BladeHalt, Anti-theft, etc.)
6. Update firmware, and change network connection
7. Unbind and add devices
8. Get help information and after-sales support

**To Use the Navimow App**

1. Please search and download the Navimow app through the APP store or Play Store.
2. Register and log in to your account
3. Turn on your phone's Bluetooth function and make sure your phone has a network signal

After registration and login, you will come to Device Activation Guidance, which will guide you to install, connect and activate your Navimow. Tap Add device.

**See the following chapters for more information:**

- *2.2 Install the Charging Station and the Antenna*
- *2.3 Charge and Activate the Mower*

Before mowing your lawn with Navimow, you need to create a work area (map) using the Navimow app. Tap "Create a map", and follow the instructions in the app. For detailed steps and tips, see *2.4 Set up the Work Area*.

Maps can also be edited or deleted on the settings page. See How to edit the map in *3.6 Settings (Mower)*.

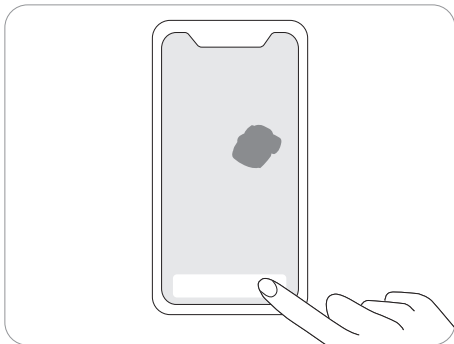



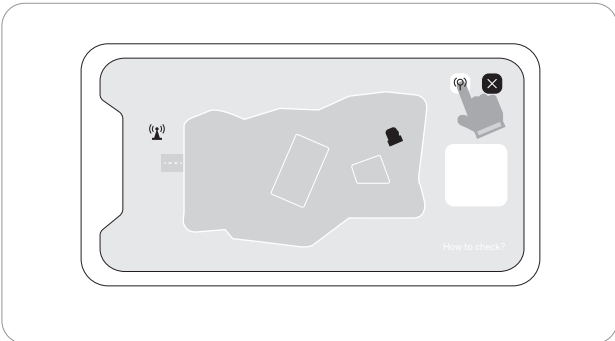





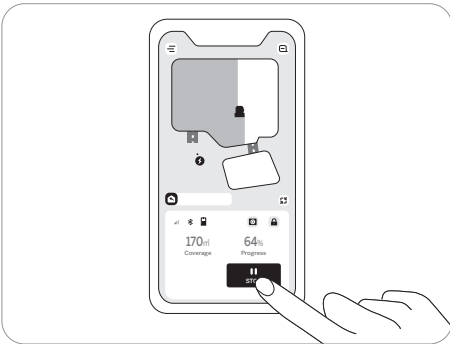



After the map is saved, satellite signal strength across the whole map will be measured and displayed. You can check or adjust the position of the charging station according to the tips in the app so that the mower can perform better. To check the signal distribution of the newly created map, you need to tap the signal icon in the upper right corner in the Navimow app. You can also tap "How to check" for further guidance and advice.



After mapping, you will come to the Homepage, where you can view the entire work area, the status of the mower, and the work progress (percentage and actual area), and remotely control the mower to start, pause or return to the charging station. Settings and Notification pages can also be accessed from here.

35



<b>Battery level</b> 	Battery level and charging status
<b>Lock status</b> 	Mower locked. Unlock the mower before any operation. See <i>how to enter PIN code in 3.1</i>
<b>Bluetooth</b> 	Bluetooth connected. When disconnected, tap to reconnect
<b>Connectivity</b>  	Connects to internet (Wi-Fi or 4G)
<b>Mower status</b>   	Displays the current status of the mower
<b>Notifications</b> 	Notifications from the device & app
<b>Settings</b> 	Settings of the mower and the app
<b>VisionFence</b> 	VisionFence sensor status

Latest news and updates from Navimow team.

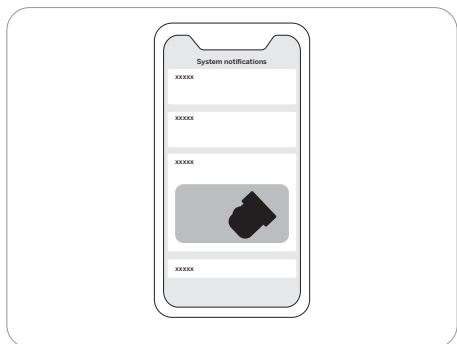

The mower will send you device notifications in the following situations: work status update (such as mowing completed), blade replacement, unexpected behaviors, abnormal position, etc.

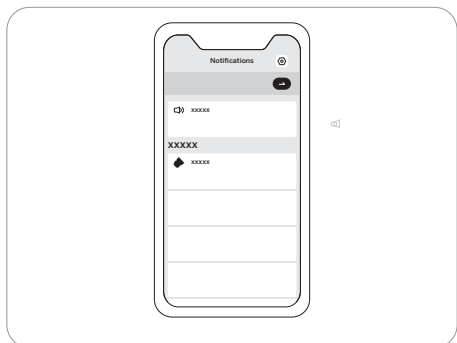

Pop-up messages appear at the center of the screen. For example, an error code message appears if an error has occurred.

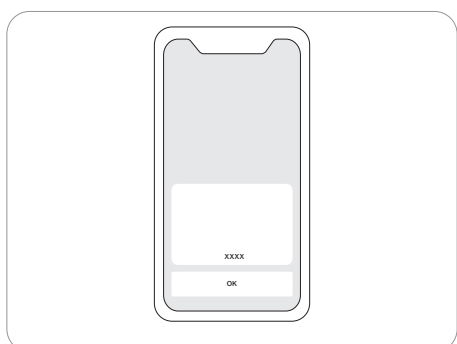

All mower-related settings can be adjusted in the app. You can:

1. Change mower work settings (mowing schedule, cutting height, map management, etc.)
2. Change mower security settings and function settings (reset PIN code, ambient light and sound settings, BladeHalt, etc.)
3. View device firmware information, network connection status, unbind devices, switch devices, etc.

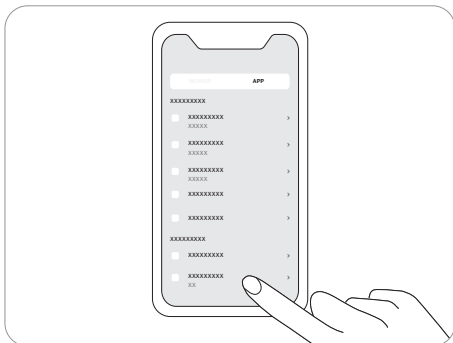

You can set the mowing schedule in the mower settings. The mower will work automatically according to the schedule.

Choose a specific date and time period on the schedule page to set your mowing schedule:

- Tap the Hour bar on the page to add or delete working hours in the pop-up page.
- Tap a day of the week to toggle the mowing schedule on/off for that day.

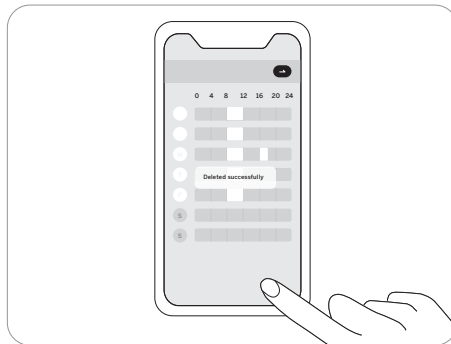
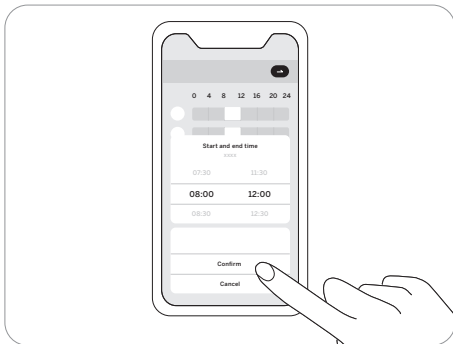

The cutting height can be adjusted in Settings >MOWER>Cutting height, the adjustment range is 30~60mm, and the minimum adjustable segment is 5mm.

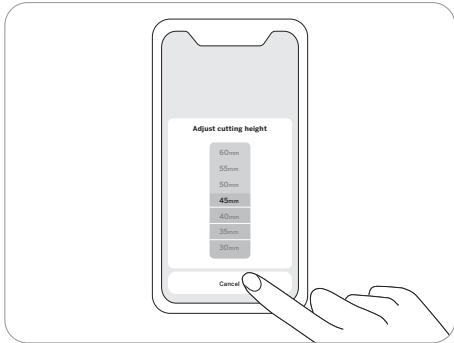

You can edit or delete the entire map in Settings>MOWER>Map management. Make sure your phone is connected to the mower via Bluetooth.

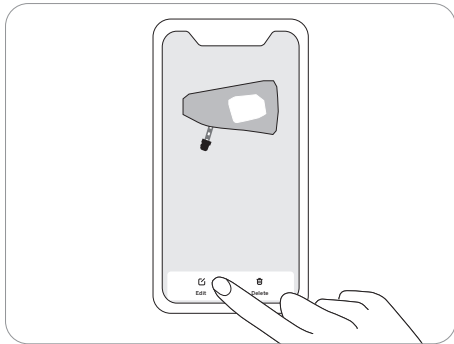

By tapping "Edit" you can: add or delete boundary, off-limit island, and channels. You can also fine-tune parts of the map. Tap a boundary or off-limit island in the map and then tap the edit icon to fine-tune the map. For the definition of boundary, off-limit island, and channels, see *2.4 Set up the Working Area*.

If it rains when mowing, the rain sensor will be triggered after receiving a certain amount of rainwater, and the mower will automatically return to the charging station. After the water on the rain sensor dries, it will automatically resume the mowing task. Before the water dries, the mower cannot be started via the app or by pressing the buttons on the mower. This is normal and not a malfunction of the mower. To continue mowing, please wait for the water to dry up and then press MOW and then OK, start via the app or wait for the next mowing schedule to start.

You can also turn off the rain sensor in Settings>MOWER>Rain sensor. See *4.1 Cleaning* for maintenance tips.

The anti-theft function can precisely locate Navimow and effectively prevent accidents such as mower theft. When moving out of a designated area, Navimow will sound an alarm and you will receive a notification on the app simultaneously. When Anti-theft is on, you can set the geofence and check Navimow's location in the map in real time.



**Operation steps:**

Step 1: Turn on Anti-theft.

Step 2: Tap 'Geofence extension' to configure the distance of the geofence extension, and then tap 'save' to save.

Step 3: Tap 'Find my mower' to check the location of the mower on the map.

**39**

In factory settings, the default PIN code: 0000. You can reset the PIN code in Settings>MOWER>Reset PIN code.

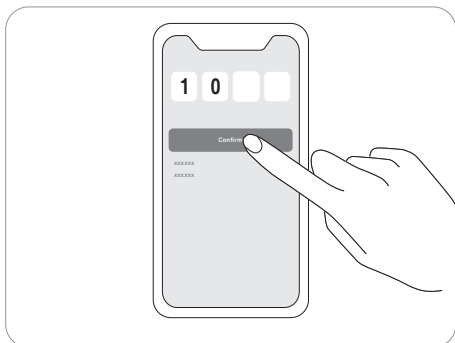

BladeHalt is a sensor that will be triggered when humans or animals touch it. This is an experimental function and will not guarantee 100% accuracy. The sensor is off by default. It will be enabled when the sensor area is touched. Meanwhile the blades will stop spinning automatically. This sensor will only work when the blade disc is spinning.

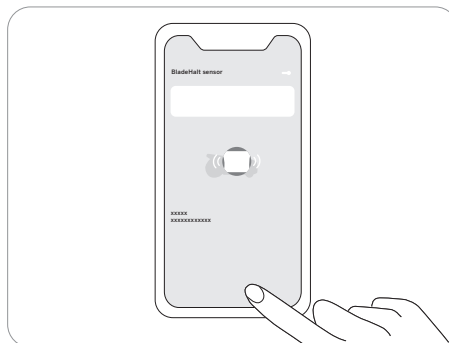



Each mower currently only supports binding to one app account. Before unbinding, it cannot be bound to another app account. You can unbind the mower in the app. When unbinding, you need to verify your identity through email or SMS verification code.

You can manage the network used by Navimow on the Network management page. For H800E, H1500E, and H3000E models, go to Settings > MOWER > Network management to switch between Wi-Fi and 4G networks.

On the Wi-Fi settings page, you can view the currently connected Wi-Fi network or reconnect to the Wi-Fi.

We will update the functions and firmware of Navimow from time to time. In order to better experience the functions of Navimow, it is recommended that you regularly check and update the firmware to the latest version.

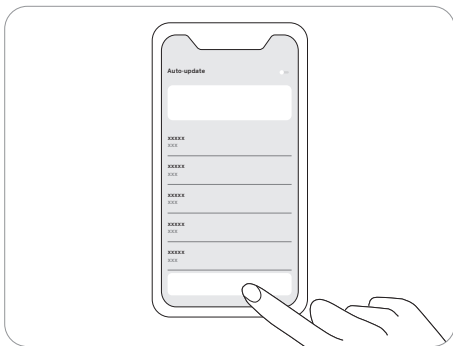

If the pop-up window for updating is closed, you can also search for the new firmware in Settings>MOWER>Firmware version to update the firmware.

Go to **Settings**>**APP** to browse and adjust the Navimow app-related settings.

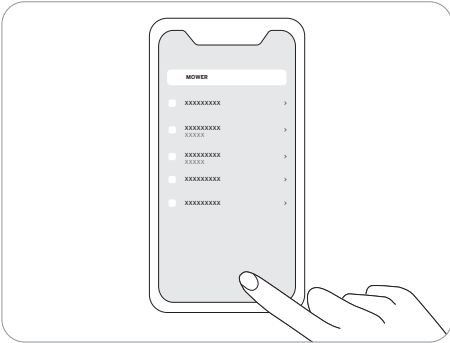

### **Account and security**

You can check your bound email address or mobile number, change the password, download the data, and delete your account.

### **Language**

You can set the language to the one that you need. Up to now, fifteen languages are supported, which are English, German, French, Dutch, Italian, Swedish, Norwegian, Finnish, Danish, Portuguese, Spanish, Russian, Czech, Slovak, and Polish.

### **Help and support**

You can view the latest User Manual, FAQ and contact of after-sales service here.

### **About**

You can view the User Agreement and Privacy Policy here.

**41**

### **Log out**

You can log out of your account here, and your data will not be deleted after logging out.

**Navimow is an Internet of Things (IoT) device. Connect the mower to the Internet via cellular network or your Wi-Fi network, enabling the following functionalities:**

1. Firmware Updates Over-The-Air (OTA), keep your mower updated to the latest features.
2. Enables remote control through the network: start mowing, stop mowing, return to charging station, set mowing schedule, set cutting height and other functions.
3. Remotely monitor the mowing progress and mower location.
4. Report error code and mower status through the network.
5. Anti-theft ( 4G connection only).

H500E model only uses Wi-Fi to connect to a network. See *Network setting in 3.6 Settings (Mower)* for more details.

H800E, H1500E and H3000E models use both Wi-Fi and cellular data networks, which will connect the mower to the Internet after activation. The usage of cellular data will incur charges. H800E and H1500E models come with one year of free data after activation. The H3000E model comes with three years of free data after activation. You can go to Settings > MOWER > Basic info in the app to check the expiration date of free data.

- When the free data period expires, you need to recharge your 4G data plan via the app so that you can continue to use the IoT and OTA functions.
- If the 4G data is not recharged, the SIM card will remain effective for 2 years. The recharging and activation can be done at anytime during these 2 years. However, after 2 years you cannot activate it anymore. You need to replace the hardware through the after-sales service. You need to pay the repairment and service fee as well.

We will update the firmware periodically to fix security vulnerabilities and improve the existing features. After firmware updating, you can experience new features and have a better use experience. When a new firmware version is available, you will receive a pop-up notification in the app. Please follow the instructions shown on the pop-up window to complete the update. A firmware update usually takes 10-15 minutes.

To manually check for updates, go to Settings > MOWER > Device management > Firmware version.

To update the firmware successfully, the following conditions need to be met:

- The mower is in the charging station.
- The mower is connected to a network and the signal is strong (through 4G or Wi-Fi).
- The battery power is more than 20%.
- There is no mowing task scheduled in the next hour.

Obstacle avoidance features are designed to increase the performance of your mower and your safety.

Sensors are installed inside the Navimow's front rubber bumper to detect obstacles. When the bumper bumps into an obstacle and triggers the sensor, the mower will go backward and avoid the obstacle.

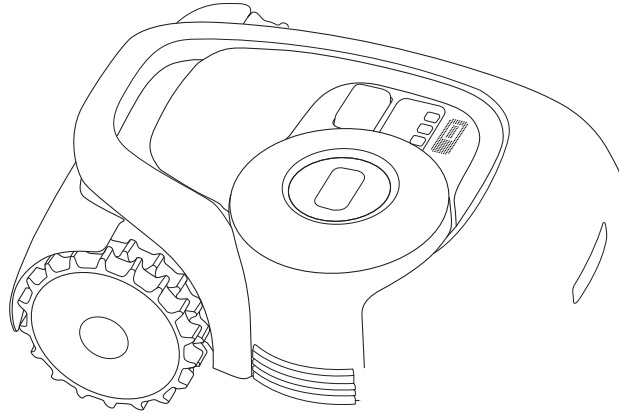

Specific models are equipped with an Ultrasonic sensor. See *1.8 Specifications* for details. The ultrasonic sensor is also sold separately and can be installed on all Navimow models. Consult your dealer for further information.

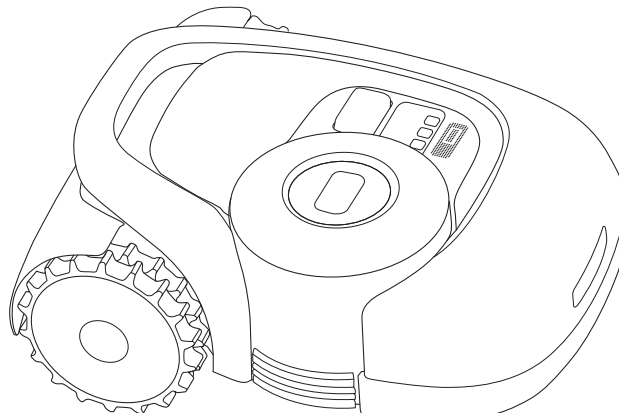

The ultrasonic sensor uses sound waves to measure the distance from an obstacle so that the mower can avoid it automatically. With the ultrasonic sensor, the mower can have higher safety performance and work more efficiently.

## How to install ultrasonic sensor

Installation guidance:

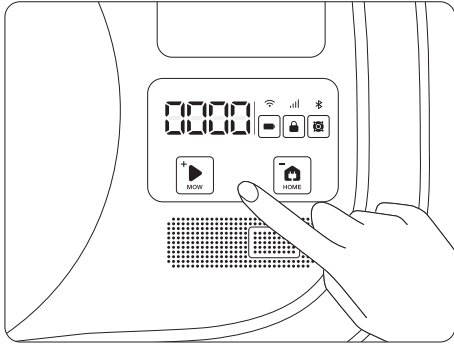

1. Power off the mower.

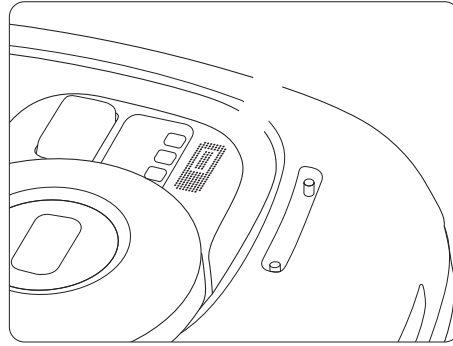

2. Take off the cover.

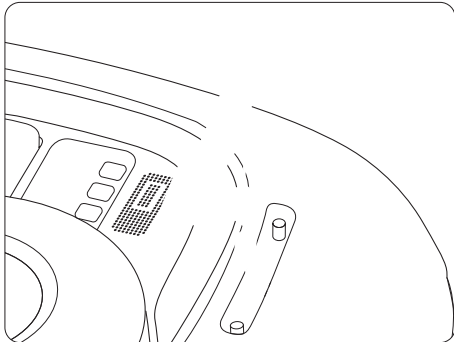

3. Connect the communication plug.

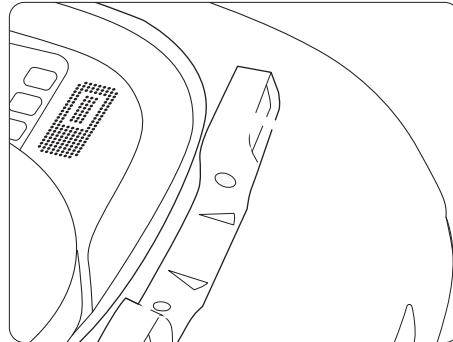

4. Use the Allen wrench to tighten the two screws.

VisionFence Sensor can significantly improve Navimow's obstacle recognition and avoidance capability. It is sold separately and can be installed on all Navimow models. Consult your dealer for further information.

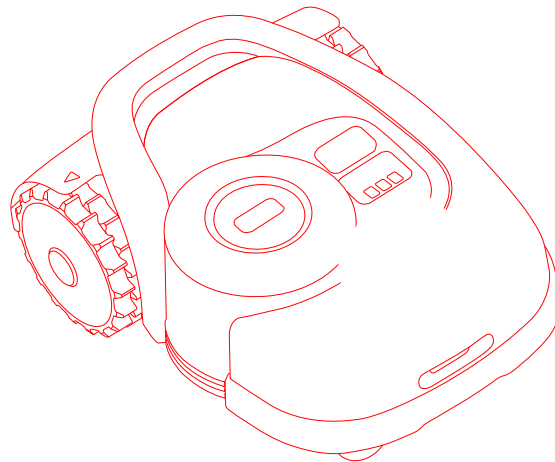

The VisionFence Sensor is designed to achieve accurate obstacle avoidance by identifying and calculating grass and non-grass objects. When the signal is weak, the mower will start avoiding obstacles through visual recognition. Thanks to the advanced visual recognition algorithm, the sensor can identify obstacles and start avoiding obstacles when the mower is about 0.3 m away from them. With the VisionFence Sensor, the mower can avoid some obstacles, such as trees and flowerpots, without setting them as off-limit islands. However, there is a certain probability that the VisionFence Sensor will fail to recognize obstacles that are too small (less than 10 cm in length and width), too thin, tilted, dangling, or easily confused with lawn. For example wire fences, moss, ornamental grass, bushes, dirt, roots, leaves, etc.

With the VisionFence Sensor installed, the mower is more adaptable to complex yards. When the satellite signal is weak in areas with challenging layouts, the VisionFence Sensor can identify the lawn's edge and allow the mower to keep mowing the lawn. Separate from the mower, the VisionFence Sensor has its own Wi-Fi module to connect to the internet. The VisionFence Sensor can function normally without network, but it must be connected to a Wi-Fi network when the firmware needs to be updated.

## How to install VisionFence Sensor

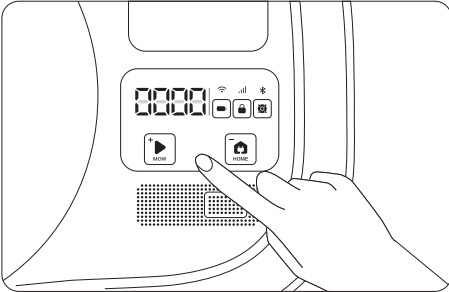

1. Power off the mower.

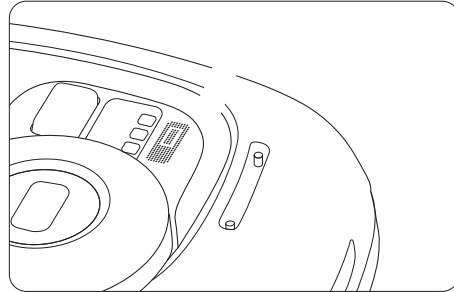

2. Take off the cover.

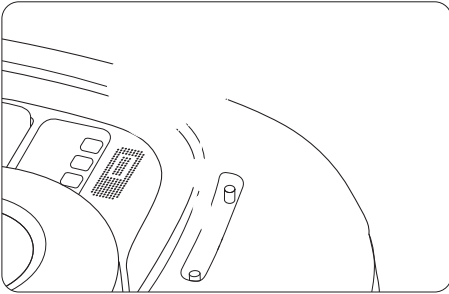

3. Connect the plug.

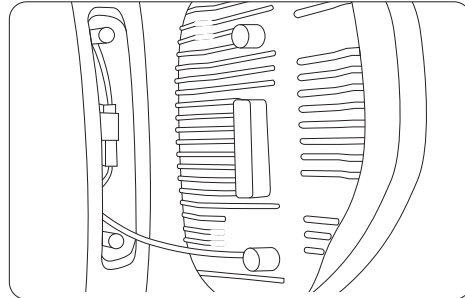

4. Place the rubber stoppers and bumps against the surface of the mower.

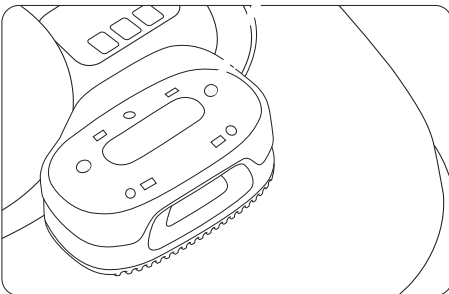

5. Tighten the screws.

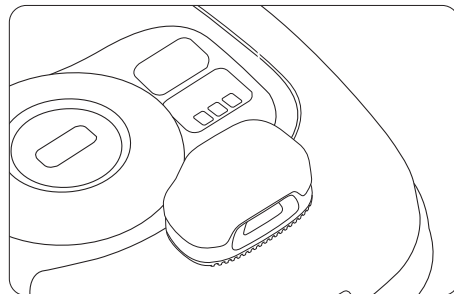

6. Install the decorative cover.

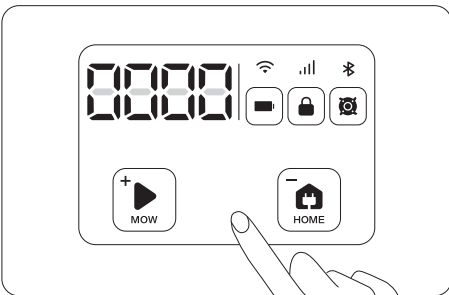

7. Power on the mower.

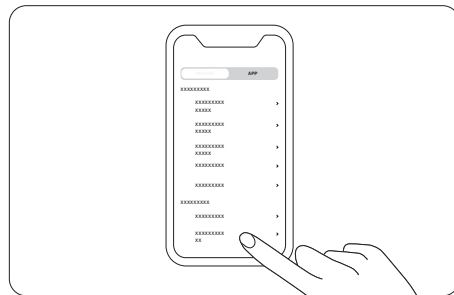

8. Tap VisionFence Sensor in the Navimow app to configure the network.

## How to change the VisionFence Sensor setting

You can go to Settings > MOWER > VisionFence Sensor to turn on/off the sensor, check the sensor firmware version and configure the sensor network setting.

The following accessories are sold separately. Please consult your dealer for details.

Antenna Extension Kit is for antenna installation on a wall or roof, improving satellite signal.

### Overview

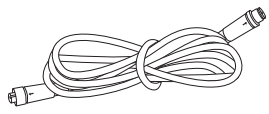

Extension cable×10m

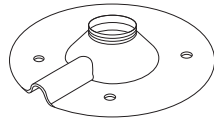

Installation base×1

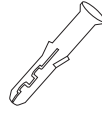

Expansion tube×4



Self-tapping screw×4



Center column×1

### How to install

Affix the center column on the installation base.

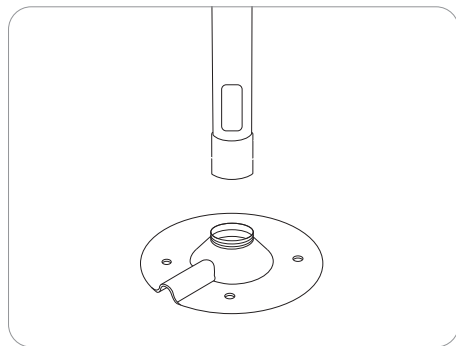

Install the GNSS antenna.

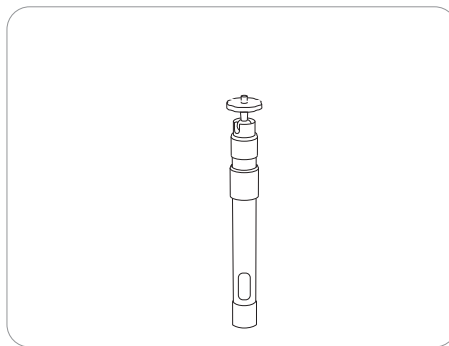

Connect the extension cable with the charging station. In case the cable is still not long enough, connect another 10 m extension cable. The total length of the extension cable can be 20 m. Insert the power plug into a suitable power outlet.

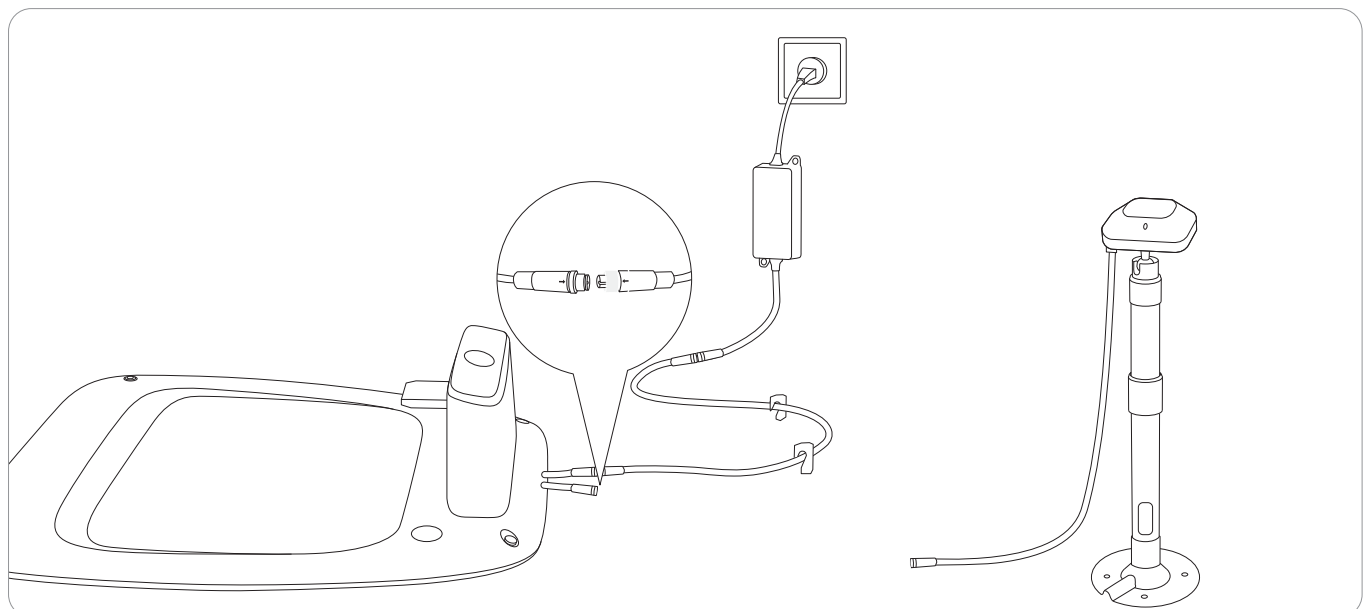

Hold the GNSS antenna to a place where you want to install it. Make sure that the top surface of the antenna points straight up. When the signal indicator on the antenna becomes solid green, the signal is strong.

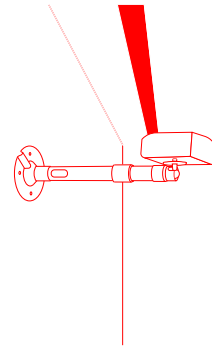
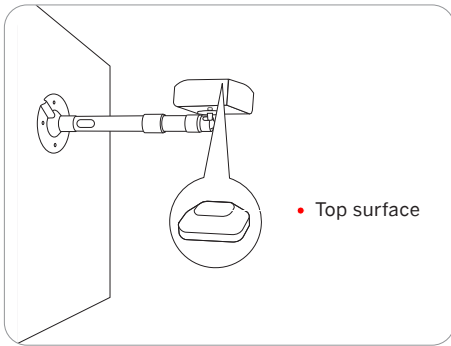

Secure the installation base.

- For a wooden surface, just secure the base with the self-tapping screws.
- For harder surfaces (like concrete, brick and stone), drill two 8 mm holes, insert the expansion tubes, and then secure the base by tightening the screws.





## Spare blades and bolts



Blades for regular replacement. For advice and how-to guides for blade replacement, see [4.2 Replace Blades](#).

Protect areas that you don't want the mower to enter.

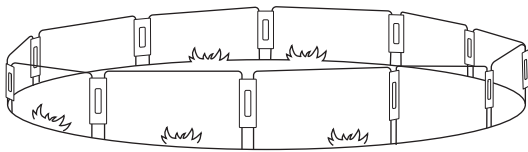

## How to Install

Insert the fencing arches into the ground to form a protective fence. Use the connecting panels to secure the arches.

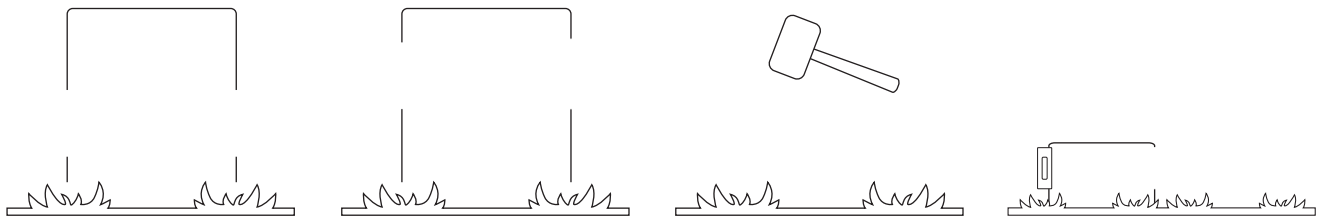

To achieve better mowing results and increase the service life, be sure to keep the mower clean and the blades in good condition. Inspection and maintenance should be carried out by an adult every week. Any damaged or worn parts should be replaced.

Use a soft brush or cloth to clean the exterior of the mower thoroughly. DO NOT clean with alcohol, gasoline, acetone, or other corrosive/volatile solvents. These substances may damage the appearance and internal structure of your mower. For proper docking, periodically inspect and clean the charging station from debris and mud. Make sure all connecting parts of the charging station, the extension cable, and the power supply are not blocked.

**A. Chassis and blade disc**

If the chassis and blade disc are dirty, use a brush or a water hose to clean. DO NOT use a high-pressure washer. At the same time, make sure that the blade disc rotates freely and the blades can pivot freely.

CAUTION: High-pressure water can leak into the sealings and damage electronic and mechanical parts.

**B. Blade fender**

Check the blade fender regularly. If mud, grass clippings or other objects gather on the blade fender, remove them with a dry brush or scraper.

**C. Wheels**

Grass on the wheels can affect how the mower performs when climbing slopes. Remove mud or other objects stuck in between to ensure strong grip.

**D. Front wheels (universal wheels)**

Inspect and clean universal wheels regularly. If the wheels are stuck, clean off the debris and lubricate the wheels.

**E. Rain sensor**

Check the rain sensor regularly and make sure the rain sensor is not covered by mud, grass clippings or other objects. You can either wash it or clean it with a soft brush. After cleaning, dry the sensor area.

If the mower is used on a regular basis, it is recommended to replace the blades and screws every 1–2 months to ensure safety and better mowing results. Replace all three blades and their screws at the same time for a safe cutting system.

Turn off the mower.

To avoid scratching, place the mower on a soft and clean surface in an upside-down position.

Use a cross-tip screwdriver to loosen the three screws.

Remove the screws and blades.

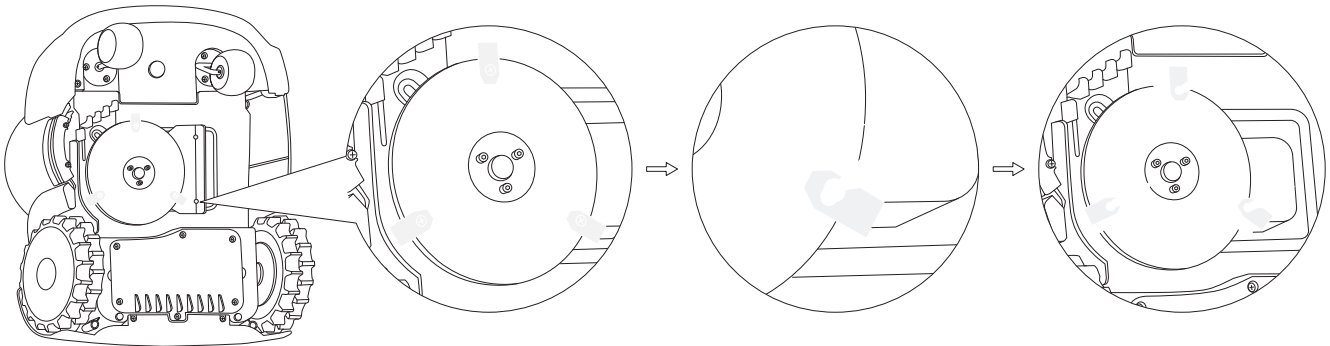

Fasten the new blades and screws (Torque: 1 N·m). Make sure the blades can pivot freely.

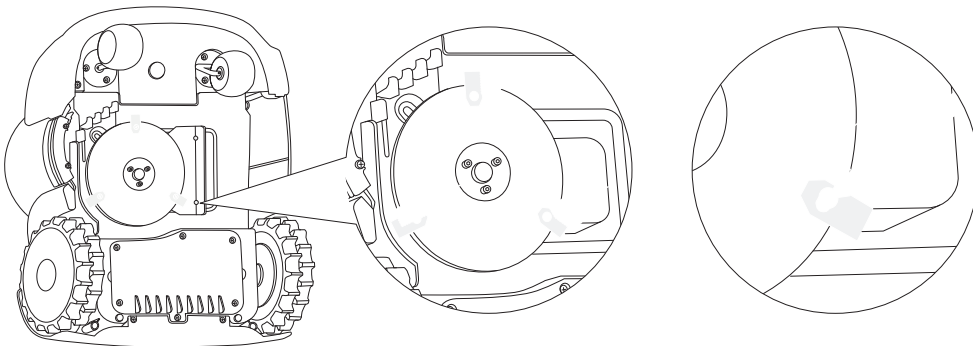

To protect the mower, use the original packaging for long-distance transportation. Before lifting, moving, or transporting the product, turn it off. Handle with care and avoid violent force, such as throwing and heavy pressure. Never pick up or carry the mower while the motor is running.

Carry the mower by the handle, with the blade disc facing away from your body.

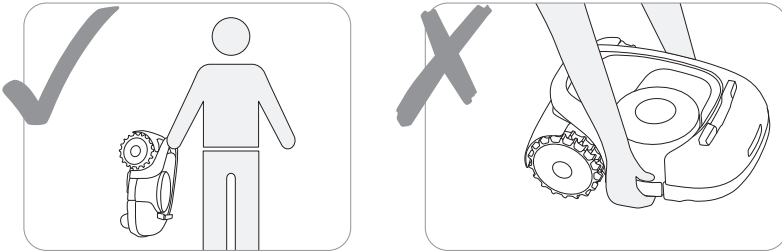

51

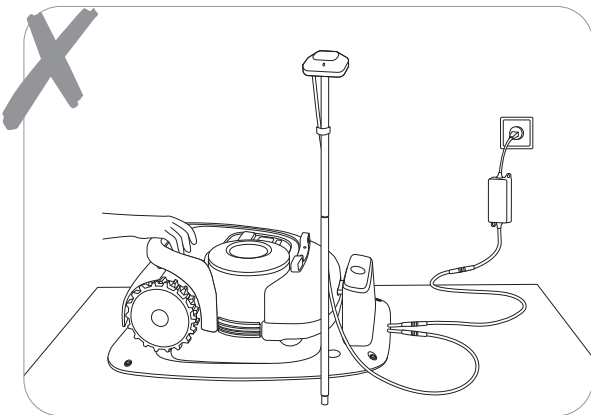

- Power off the mower and charge its battery to 85% or higher before storage to avoid over-discharge and damage to the electrical components. Charge the mower every 120 days for long-time storage.
- Battery damage caused by over-discharge will not be covered by the Limited Warranty.
- DO NOT use or store the battery under extreme temperature conditions, i.e., above 50°C (122°F) or below -20°C (-4°F).
- Temperature protection will be activated at 0°C (32°F)/50°C (122°F), the battery won't be charged unless the temperature reaches 5°C (41°F) or above/reduces to 45°C (113°F) or below.

When the battery temperature is too high or too low, the mower will not start mowing. You will also receive a push notification in the Navimow app.

Turn off the mower.

Place the mower on a soft and clean surface in an upside-down position.

Use a cross-tip screwdriver to loosen the 6 screws on the battery compartment.

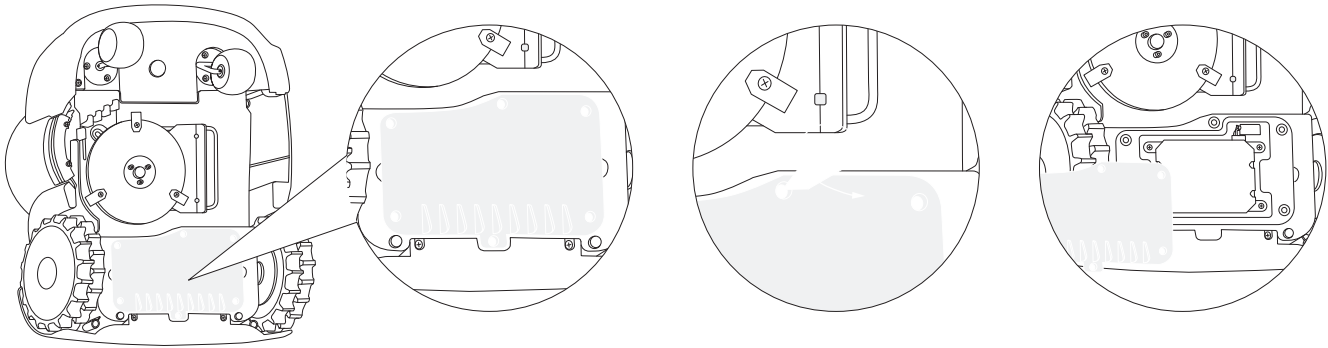

Loosen the 4 screws in the battery compartment.

Disconnect the two plugs.

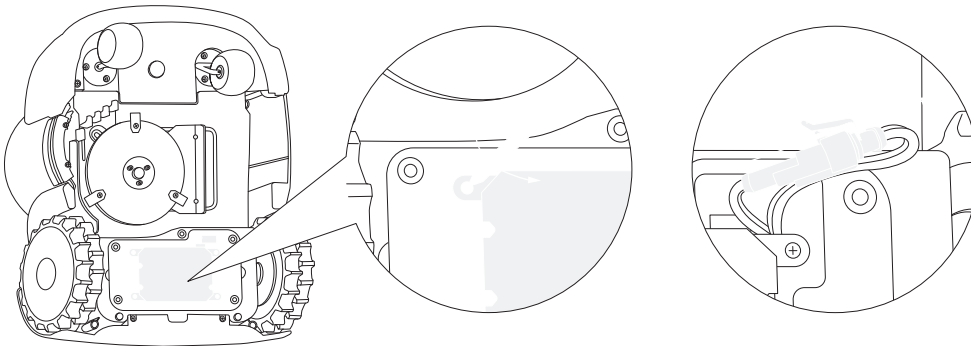

Take out the battery pack and replace it with the new one.

Connect the plugs and tighten all the screws.

- Disconnect the power supply:
  - Before clearing a blockage;
  - Before checking, cleaning or working on the machine;
  - After striking a foreign object to inspect the machine for damage.
- Regularly examine the cord, plug, enclosure and other parts. If any damage or signs of aging are found, stop using immediately.

### **Recommendation**

Connect the mower and/or its peripherals only to a supply circuit protected by a residual current device (RCD) with a tripping current of not more than 30 mA.

---

## **53**

- Before storage, power off the mower and charge its battery to 85% or higher to avoid over-discharge, which will cause permanent damage.
- Store in a cool and dry place indoors. Exposure to sunlight and temperature extremes (both hot and cold) will accelerate the aging process of the components and may permanently damage the battery.
- Keep the mower, charging station and power supply away from heat sources (such as stoves, radiators, etc.) or chemicals. Protect the power supply from moisture and keep it in a well-ventilated place.

### **Extra requirements for winter storage**

- The mower  
Clean the mower thoroughly before storage. Check the components subject to wear such as the blades. Repair or replace them if they are in poor condition. Store the mower in a dry and frost-free place, while standing on all wheels, preferably in the original packaging.
- The charging station and GNSS antenna  
Unplug the power supply from the power socket and disconnect it from the charging station. Disconnect the GNSS antenna from the charging station and take it down from the standing pole or the antenna extension kit. Keep the charging station and GNSS antenna indoors and out of direct sunlight.

For more information, visit <https://navimow.zendesk.com/hc/en-001/articles/11039122526489>

DO NOT treat this product as domestic waste. For recycling information, contact your domestic waste service, your municipality, or point of sale.

- Keep all screws, nuts and bolts tight to ensure normal and safe operation.
- Tyres supplied with the product are to be mounted on the wheel by a professional repairer. Removing the wheels is complicated and incorrect assembly can lead to instability and malfunctions.
- To ensure good grip of the tread, keep the drive wheels (rear wheels) clean by removing any mud with a brush.
- The chassis compartment behind the bumper must be opened and resealed by authorized service technicians ONLY. Servicing by yourself can void the Limited Warranty.

**NOTICE: INSURANCE**

**YOUR INSURANCE POLICIES MAY NOT PROVIDE COVERAGE FOR ACCIDENTS INVOLVING THE USE OF THIS PRODUCT. TO DETERMINE IF COVERAGE IS PROVIDED, PLEASE CONTACT YOUR INSURANCE COMPANY OR AGENT.**

The following chart offers a guide to help identify an issue, and if possible, repair by yourself. When the problem cannot be solved, consult an authorized dealer or repairer.

Issue	Possible Causes	Solutions
Abnormal vibration when the mower is operating	A damaged blade disc	Check the blades and the blade disc. Replace if damaged or worn. The blade disc has to be replaced by an authorized technician.
Delayed mower movement when laying the boundary via the app	Unstable Bluetooth signal	Stay close to the mower (within 6 meters) when laying the boundary.
The mower cannot get accurate GPS location persistently	<ol style="list-style-type: none"> <li>1. The GNSS antenna on the mower is covered or blocked</li> <li>2. The GNSS antenna or charging station is covered or blocked</li> <li>3. The firmware version is too old</li> </ol>	<ol style="list-style-type: none"> <li>1. Make sure the mower is not covered by anything.</li> <li>2. Remove anything that is covering or blocking the charging station, or relocate the GNSS antenna to a place with a good signal.</li> <li>3. Update to the latest firmware</li> </ol>
Shorter working hours per full charge	<ol style="list-style-type: none"> <li>1. Aged battery pack</li> <li>2. Lawn condition (long grass, changed garden layout, etc.)</li> </ol>	<ol style="list-style-type: none"> <li>1. Replace the battery pack.</li> <li>2. This is normal.</li> </ol>
It takes less time to fully charge the mower	Aged battery pack	Replace the battery pack.
The mower does not charge or it turns off automatically in the charging station	<ol style="list-style-type: none"> <li>1. High/low battery temperature</li> <li>2. The charging station is not connected to the power socket</li> <li>3. The contact strip is unclean</li> </ol>	<ol style="list-style-type: none"> <li>1. When the mower temperature returns normal, try charging again.</li> <li>2. Connect the charging station to the power supply and plug it into the power socket.</li> <li>3. Clean the contact strip.</li> </ol>
The mower does not work according to the schedule	<ol style="list-style-type: none"> <li>1. The STOP button is pressed down or jammed and the mower cannot start automatically</li> <li>2. Low battery</li> <li>3. Water on the rain sensor</li> </ol>	<ol style="list-style-type: none"> <li>1. Make sure the STOP button is completely released. Turn off the mower and check if there is any foreign object stuck in the STOP button. If yes, remove the object and try mowing again.</li> <li>2. Charge the mower battery to <math>\geq 85\%</math>.</li> <li>3. If the rain sensor is triggered, the mower cannot start working. Wait for the water to dry up or turn off the rain sensor in the app.</li> </ol>
The mower does not go back to the charging station	<ol style="list-style-type: none"> <li>1. The GNSS antenna is blocked</li> <li>2. The charging station is covered or blocked by obstacles</li> <li>3. Items are blocking the upper surface of the mower so that the built-in GNSS antenna cannot receive the signal well</li> </ol>	Remove all obstacles covering, blocking or surrounding the charging station and the antenna.
The mower is stuck	<ol style="list-style-type: none"> <li>1. The wheels lost traction because of mud or grass</li> <li>2. Soft ground such as sand</li> <li>3. Deep ditch</li> </ol>	<ol style="list-style-type: none"> <li>1. Remove anything that's stuck on the wheels.</li> <li>2. Set soft areas as off-limit islands when necessary.</li> <li>3. Fill in the gap and keep the lawn surface level and flat.</li> </ol>
The mower goes outside the boundary	<ol style="list-style-type: none"> <li>1. The wheels lost traction because of mud or grass</li> <li>2. The boundary is set on a slope</li> <li>3. Weak satellite signal reception</li> </ol>	<ol style="list-style-type: none"> <li>1. Remove anything that's stuck on the wheels.</li> <li>2. Change the location of the boundary.</li> <li>3. Try to install the antenna in a relatively open space to allow the antenna to have a clear view of the sky, where at least <math>110^\circ</math> of the sky is unobstructed.</li> </ol>
The mower does not move in a regular pattern in certain areas	There are obstacles in the area	The mower will automatically adjust its moving pattern and resumes to normal.
Uneven or patchy mowing	<ol style="list-style-type: none"> <li>1. The preset mowing time is insufficient</li> <li>2. The blades are blunt</li> <li>3. The grass is too high</li> <li>4. The blades cannot pivot normally</li> </ol>	<ol style="list-style-type: none"> <li>1. Adjust the mowing time so that it matches the mowing area and the mower has enough time to finish the task.</li> <li>2. Replace the blades.</li> <li>3. Set the cutting height to a higher level and then lower to the desired height gradually.</li> <li>4. Clean the blades.</li> </ol>
The mower cannot power on	The battery is over-discharged	Place the mower in the charging station, fully charge it, and restart the mower.
The mower cannot connect to a Wi-Fi network	<ol style="list-style-type: none"> <li>1. The mower is too far away from the router</li> <li>2. The Wi-Fi network is not 2.4 GHz</li> <li>3. Wi-Fi permission is not granted to Navimow app</li> </ol>	<ol style="list-style-type: none"> <li>1. Place the mower closer to the router.</li> <li>2. Connect the mower to a 2.4 GHz Wi-Fi network.</li> <li>3. Grant permission to the app.</li> </ol>



Issue	Possible Causes	Solutions
The mower mows the lawn by itself without any manual operation	<ol style="list-style-type: none"> <li>1. Manual mowing mode (start mowing either via the app or by pressing the mower buttons)</li> <li>2. Mowing schedule</li> <li>3. Rain sensor</li> </ol>	<ol style="list-style-type: none"> <li>1. If you started manual mowing mode before, the mower will keep working until 100% of the mowing task is completed. When the battery level is lower than 10%, the mower will return to the charging station. When the battery is charged to 85%, the mower will resume the previous mowing task automatically. When the mowing task is completed (100%), the mower will exit the manual mowing mode.</li> <li>2. If you have set a mowing schedule (and you didn't start manual mowing before), the mower will automatically start the mowing task according to the schedule. When the battery level is lower than 10%, the mower will return to the charging station. When the battery is charged to 85%, the mower will resume the previous mowing task automatically until the mowing task is completed (100%).</li> <li>3. When the rain sensor is triggered, the mower will stop the task and return to the charging station. After the water on the rain sensor is dry, it will automatically continue until the mowing task is finished. However, if it's past the scheduled time, the mower will not resume mowing.</li> </ol>
The mower does not cut the grass, or the blades stop rotating during the mowing process	<ol style="list-style-type: none"> <li>1. Cutting motor over-current protection</li> <li>2. Foreign objects</li> <li>3. Obstacle avoidance</li> <li>4. The mower does not cut when going back to the charging station, or when going to the starting point of the mowing session. This is normal and the mower will only cut on the planned cutting path.</li> </ol>	<ol style="list-style-type: none"> <li>1. When the grass is too thick, the cutting motor will automatically enter self-protection and stop rotating when the current is too high. At this time, it is recommended to increase the mowing height, or use other mowing tools to trim the lawn to 6cm or lower first.</li> <li>2. Please confirm whether there is any foreign object stuck in blade disc or blades, if any, please clean it in time.</li> <li>3. When the mower is avoiding an obstacle, the bump sensor will shut down the blades temporarily. When this protection mechanism is finished, the blades will continue rotating.</li> <li>4. Normal</li> </ol>
Certain areas are not cut	<ol style="list-style-type: none"> <li>1. Inaccurate positioning</li> <li>2. Obstacle avoidance</li> <li>3. Tall grass</li> </ol>	<ol style="list-style-type: none"> <li>1. The mower's moving path depends on satellite positioning, occasionally inaccurate positioning may lead to missed cuts, and the missed area will be covered after a few more cuts.</li> <li>2. If an obstacle is encountered during mowing, the mower will avoid the obstacle, which can result in certain areas not being cut. This is normal and a new feature will be added to make the mower cut the missed area with obstacles again.</li> <li>3. If the grass is higher than 15cm, the ultrasonic sensor will be triggered and the mower will avoid areas with high grass.</li> </ol>

When there is an abnormality, an error code is shown in the app and the mower display. Below is a list of the error codes, what they mean and what to do:

Error Code	Meaning	Solution
1001	Mowing motor initialization failed	Please keep the mower still, and try to restart the mower. If the error persists, contact after-sales service.
1002	Mowing motor overvoltage protection	Please press the STOP button on the mower. If the error persists, contact after-sales service. Do not disassemble the battery pack and make sure to use a genuine battery.
1003	Mowing motor undervoltage protection	Please charge the mower until it has more than 50% battery (the battery indicator becomes green), then press the STOP button on the mower. If the error persists, contact after-sales service. Do not disassemble the battery pack and make sure to use a genuine battery.
1004	Mowing motor overcurrent protection	Please press the STOP button on the mower. If the error persists, contact after-sales service.
1005	Mowing motor stall protection	For your safety, power off the mower first. 1. Check if the blade disc is stuck, remove the foreign objects. 2. Check if the grass is too thick and dense, cut your lawn to a height of no more than 6 cm. Restart the mower and resume mowing. If the error persists, contact after-sales service.
1008	Cutting height motor stall protection	For your safety, power off the mower first. Check if there are foreign objects above the blade fender, such as grass clippings, stones, etc., and clean it up. Restart the mower, and adjust the cutting height to 60 mm for testing. If the error persists, contact after-sales service.
1009	Cutting height motor overcurrent protection	
1010	NCU self-check failure	Please restart the mower and resume mowing. If the error persists, contact after-sales service.
1018	Cutting height motor control failure	Please restart the mower and resume mowing. If the error persists, contact after-sales service.
1020	Battery overvoltage protection	Please press the STOP button on the mower. If the error persists, disconnect the mower from the charging station, and contact after-sales service. Do not disassemble the battery pack and make sure to use a genuine battery.
1021	Battery undervoltage protection	The battery is over-discharged and needs to be charged. If the battery temperature is lower than 0 degrees or higher than 48 degrees, wait for the temperature to return to above 5 degrees or below 44 degrees before charging. After charging to 50% power, press the STOP button to clear it. If the error persists, disconnect the mower from the charging station, and contact after-sales service. Do not disassemble the battery pack and make sure to use a genuine battery.
1022	Battery discharging protection	Please press the STOP button on the mower. If the error persists, shut down the mower immediately, and contact after-sales service.
1023	Battery charging protection	Please press the STOP button on the mower. If the error persists, take the mower out of the charging station and contact after-sales service. Do not disassemble the battery pack and make sure to use a genuine battery.
1024	Battery temperature is too high	Place the mower in the shade (operating temperature: 0-40 degrees Celsius), then press the STOP button on the mower. If the error persists, contact after-sales service. Do not disassemble the battery pack and make sure to use a genuine battery.
1025	Battery temperature is too low	Place the mower in a warm environment (operating temperature: 0-40 degrees Celsius), then press the STOP button on the mower. If the error persists, contact after-sales service. Do not disassemble the battery pack and make sure to use a genuine battery.
2010	Sensor system self-check failure	Please restart the mower and then put it in the charging station. If the error persists, contact after-sales service.
3001	Hub motor stall protection	Please check if the wheels are stuck. Remove the foreign objects, then press the STOP button on the mower and press MOW+OK to resume mowing. If the error persists, contact after-sales service.
3002	Hub motor overspeed protection	Please press the STOP button on the mower and press MOW+OK to resume mowing. If the error persists, contact after-sales service.
3003	IMU bias error	Please keep the mower level and still, restart the mower. If the error persists, contact after-sales service.
3004	Hub motor calibration error	Power off the mower, and lift the rear wheels off the ground by the lifting handle. Then, power on and wait for the rear wheel to rotate and calibrate. After calibration, continue to use it as usual. If the error persists, contact after-sales service.
3005	Hub motor short circuit protection	Please restart the mower and then put it in the charging station. If the error persists, contact after-sales service.
3006	Hub motor calibration corrupted	Please press the STOP button on the mower and press MOW+OK to resume mowing. If it fails, restart the mower and then put it in the charging station. If the error persists, contact after-sales service.
3007	Hub motor communication error	Please restart the mower and then put it in the charging station. If the error persists, contact after-sales service.
3008	Hub motor over temperature	Please wait for about 1 minute before the temperature returns to normal. Then, press the STOP button on the mower and press MOW+OK to resume mowing. If the error persists in the same area, set the area as an off-limit island.
3010	VCU self-check failure	Please restart the mower and then put it in the charging station. If the error persists, contact after-sales service.
4001	Storage system error	
4003	ECU over temperature	Place the mower in the shade (operating temperature: 0-40 degrees Celsius), then press the STOP button on the mower. If the error persists, contact after-sales service.
4004	VCU over temperature	
4007	Bluetooth link error	Please press the STOP button on the mower and press MOW+OK to resume mowing. If it fails, restart the mower and then put it in the charging station. If the error persists, contact after-sales service.
4008	IoT link error	
4010	Mower motor communication error	
4011	Charging station communication error	Please make sure the charging station is plugged into a power outlet, and the distance between the charging station and the mower is within 200 meters. Please press the STOP button on the mower and press MOW+OK to resume mowing. If it fails, restart the mower and then put it in the charging station. If the error persists, contact after-sales service.

Error Code	Meaning	Solution
4013	Ultrasonic module communication error	Please make sure the ultrasonic sensor cables are connected correctly, then restart the mower. If the error persists, contact after-sales service.
4020	ECU system self-check failure	Please restart the mower and then put it in the charging station. If the error persists, contact after-sales service.
5001	Unable to connect GNSS antenna	Please check if the GNSS antenna is connected to the charging station, then press the STOP button on the mower. If the error persists, contact after-sales service.
5002	Charging station guiding wire error	Please re-plug the charging station into the power supply, then press the STOP button on the mower. If the error persists, contact after-sales service.
5003	Charging station overcurrent or overvoltage protection	
5005	GNSS antenna data error	Please reconnect the GNSS antenna to the charging station, and then press the STOP button on the mower. If the error persists, contact after-sales service.
6002	Mower is outside the boundary	Please place the mower on an open and flat surface within the boundary, and press the STOP button on the mower. When the mower light turns blue, press MOW+OK to resume mowing. If it fails, restart the mower and then put it in the charging station. If the error persists in the same area, set the area as an off-limit island.
6003	Mower has turned over	Please place it in the proper position and put it back in the boundary or charging station. Press the STOP button on the mower, and then press MOW+OK to resume mowing. Please set the area where the mower turns over frequently as an off-limit island.
6004	Mower cannot return to the charging station	Please confirm no obstacles in the path and the charging station is installed on a flat surface. Press the STOP button on the mower, then HOME+OK to return. If the error persists, check if the charging station and the antenna have been moved since the previous mapping and rebuild the map. If it still cannot be solved, contact the after-sales service.
6005	Mower cannot return to the charging station	Please confirm no obstacles in the path and the charging station is installed on a flat surface. Press the STOP button on the mower, then HOME+OK to return. If the error persists, check if the charging station and the antenna have been moved since the previous mapping and rebuild the map. If it still cannot be solved, contact the after-sales service.
6006	Bumper sensors triggered constantly	Please remove the obstacles or tap the sensor gently to release it, then press the STOP button and press MOW+OK to resume mowing. If it fails, restart the mower and then put it in the charging station. If the error persists, contact after-sales service.
6007	Mower is lifted	Please place the mower on a flat surface and check if the front wheels are stuck, then press the STOP button and press MOW+OK to resume mowing. If it fails, restart the mower and then put it in the charging station. If this happens frequently, contact after-sales service.
6008	Bumper sensor triggered too many times	Please remove the obstacles, then press the STOP button and press MOW+OK to resume mowing. If it fails, restart the mower and then put it in the charging station.
6010	Motion planning error	Please relocate the mower to a flat spot within the boundary, press the STOP button to clean error code, Press MOW+OK to resume mowing. Please set the area where the mower stuck frequently as an off-limit island.
6011	Motion planning error	Please check if the mower is stuck. Remove the foreign objects, then press the STOP button on the mower and press MOW+OK to resume mowing. Please set the area where the mower stuck frequently as an off-limit island.
6014	Motion planning error	Please remove the mower from the obstacles and place it on a flat surface within the boundary. Press the STOP button on the mower and press MOW+OK to resume mowing. Please set the area where the mower stuck frequently as an off-limit island.
6015	Motion planning error	Please confirm no obstacles in the path and the charging station is installed on a flat surface. Press the STOP button on the mower, then HOME+OK to return. If the error persists, check if the charging station and the antenna have been moved since the previous mapping and rebuild the map. If it still cannot be solved, contact the after-sales service.
6016	Motion planning error	
6017	Mower gets stuck in obstacles	
6018	Motion planning error	
7001	IMU/TICKS data error	Please remove the obstacles or tap the sensor gently to release it, then press the STOP button and press MOW+OK to resume mowing. If it fails, restart the mower and then put it in the charging station. If the error persists, contact after-sales service.
7002	Fail to read VCU version	
7003	GPS data error	
7004	Compass data error	
7005	Localization data streaming fault	
7006	Localization recovery is not successful	Check if there are obstacles or complex terrain around the mower. To help the mower to recover localization, place it in an open and flat area. Press the STOP button and then resume mowing or parking.
8001	VisionFence sensor communication error	Please press the STOP button on the mower and press MOW+OK to resume mowing. If it fails, restart the mower. If the error persists, contact after-sales service.
8002	VisionFence sensor map error	
8003	Stained camera	Please clean the camera lens, then press the STOP button on the mower and press MOW+OK to resume mowing. If the error persists, contact after-sales service.
8005	VisionFence sensor disconnected	Please check if the VisionFence sensor is disconnected from the mower. If you intended to do so, please disable the VisionFence sensor in APP setting. If the error persists, contact after-sales service.
8006	VisionFence sensor system error	A system error occurred in VisionFence sensor. Please restart the mower. If the error persists, contact after-sales service.

Segway, Powered by Segway, Navimow and the Rider Design are the registered trademarks of Segway Inc., Android, Google Play are trademarks of Google Inc., App Store is a service mark of Apple Inc., The respective owners reserve the rights of their trademarks referred to in this manual.

We have attempted to include descriptions and instructions for all the functions of the Navimow at the time of printing. However, due to constant improvement of product features and changes of design, your Navimow may differ slightly from the one shown in this document. Visit the Apple App Store (iOS) or Google Play Store (Android) to download and install the Navimow app. Please note that there are multiple Segway models with different functions, and some of the functions mentioned herein may not be applicable to your unit. The manufacturer reserves the right to change the design and functionality of the Navimow product and documentation without prior notice.

© 2023 Willand (Beijing) Technology Co., LTD. All rights reserved.

### Navimow Legal Statement:

IMPORTANT: The user shall agree to read the entire user manual and fully understand its content (especially the parts related to safety warnings) and adhere to the instructions herein before using this product.

1. Navimow is an electric household with blades, it can be dangerous to a user, other persons and property in proximity thereto. The user shall assume all the risks and loss in connection with the product (especially for those related to and/or arising out of violation of the instructions about safety warnings). Such risks include but not limited to injuries, bodily injuries and/or damages to property. SEGWAY and its affiliates shall not be liable for any claim, liability and loss related to such consequences, if it is due to the user's assumption of risk.
2. Please check and obey your local laws or regulations over the product. It is SOLE User's responsibility THAT HE/SHE SHALL USE AND/OR DISPOSE OF THE PRODUCT IN COMPLIANCE WITH THE LAW IN YOUR JURISDICTION.
3. A consumer shall immediately check whether the product and its accessories are in good condition upon receipt of the product.
4. All the separate components and part of the Navimow must be properly installed as per the User Manual. Inappropriate installation may lead to unexpected accidents. The Mower may contain removable components and small parts. Please keep it out of the reach of children to avoid choking hazards.
5. DO NOT allow children to be in the vicinity or play with the machine when it is operating.
6. Please note the safety warnings listed in the User Manual, including but not limited to:  
 Always keep the mower within 6 meters away from you, and DO NOT let it get out of your eyesight when it is operating.  
 DO NOT wear open sandals or be barefoot when mowing.  
 DO NOT mow on slopes greater than 45%.  
 DO NOT attempt to charge your mower if it, the power supply, the charging station, or the power socket is wet.  
 DO NOT charge the mower when the temperature is above 45°C(113°F) or below 5°C(41°F).  
 DO NOT connect the power supply to the power socket if the cord or the plug is damaged.  
 Keep away from inflammable and explosive materials when charging.  
 When there is an abnormal smell, sound, or light display, stop charging immediately and contact after-sales service.  
 DO NOT ride on the machine.  
 DO NOT touch rotating blade.
7. Do not dispose of this product in a landfill, by incineration, or by mixing with household trash. Serious danger/injury can occur because of the electrical components and the battery. For information about battery and electrical waste, please contact your household waste disposal service, your local or regional waste management office, or your point-of-sale.
8. The user shall not use any non-original accessories, or dismantle or modify the product without authorization. All damages, injuries and damages to property arising therefrom will be your sole responsibility and risk.
9. NEITHER SEGWAY (SEGWAY DISCOVERY B.V. AND ITS SUBSIDIARIES AND AFFILIATES) NOR WILLAND (WILLAND (BEIJING) TECHNOLOGY CO., LTD. AND ITS SUBSIDIARIES AND AFFILIATES) IS SUBJECT TO NO COMPENSATION RESPONSIBILITY OF ANY CLAIM, LIABILITY AND LOSS THAT ARISES (OR MAY ARISE) FROM VIOLATING ANY OF THE ABOVEMENTIONED CLAUSES OR ANY INJURIES, DAMAGES OR LEGAL DISPUTES CAUSED BY A USER'S INEXPERIENCE OR FAILURE TO FOLLOW THE INSTRUCTIONS IN THIS MANUAL.
10. SEGWAY reserves the right to make changes to the product, release firmware updates, and update this manual at any time. Improvements and changes to this user manual necessitated by typographical errors, inaccuracies of current information, or improvements to programs and/or equipment, may be made by SEGWAY at any time and without notice. Such changes will, however, be incorporated into new editions of this user manual. All illustrations are for illustration purposes only and may not accurately depict the actual device. Actual product and functions may vary. Due to the update of the product, there may be some deviations in color, appearance and other aspects between the product listed in this manual and the product you actually purchased. Please refer to the actual product.
11. This document should be considered as a permanent part of the product and it shall be provided to the user together with the product all the time.

Thank you again for choosing Navimow!

**Manufacturer**

**Name:** Willand (Beijing) Technology Co., LTD.

**Address:** Room 203, A1 Bldg. Zhongguancun Dongsheng Technology Park (Northern Territory), No. 66, Xixiaokou Rd, Haidian Dist., Beijing, China.

**Authorized Representative**

**Name:** Segway Discovery B.V.

**Address:** Dynamostraat 7, 1014BN Amsterdam, The Netherlands

**Contact Person:** Antonio Rapisarda

**Function:** Account Director

**Object of the declaration**

**Generic designation:** Robotic Lawnmower

**Product name:** Navimow

**Type/model:** H500E/H800E/H1500E/H3000E

**Serial number:** S2RA x yyyy x yyyy/S2RC x yyyy x yyyy/S2RE x yyyy x yyyy/S2RT x yyyy x yyyy

("x" indicates any letter from A-Z except O and I, "y" indicates any letter from A-Z except O and I or any number from 0-9)

**This Declaration of Conformity is issued under the sole responsibility of the manufacturer.**

The object of the declaration described above is in conformity with the following EU Directives:

1. Radio Equipment Directive (2014/53/EU)
2. Machinery Directive (2006/42/EC)
3. RoHS Directive (2011/65/EU) and amending directive ((EU)2015/863)

**Conformity with these Directives has been assessed for this product by demonstrating compliance to the following harmonized standards and/ or technical specifications:**

EN 60335-1:2012+A11:2014+AC:2014+A13:2017+A1:2019+A14:2019+A2:2019

EN 50636-2-107:2015+A1:2018+A2:2020

EN IEC 61000-3-2:2019+A1:2021

ETSI EN 301 908-1 V13.1.1

EN 61000-3-3:2013+A1:2019

ETSI EN 301 908-13 V13.1.1

EN IEC 55014-1:2021

ETSI EN 301 489-1 V2.2.3

EN IEC 55014-2:2021

ETSI EN 301 489 - 3 V2.2.0

ETSI EN 300 220-1 V3.1.1

ETSI EN 301 489-17 V3.2.4

ETSI EN 300 220-2 V3.1.1

ETSI EN 301 489-19 V2.1.1

ETSI EN 300 328 V2.2.2

ETSI EN 301 489-52 V1.2.1

ETSI EN 303 413 V1.1.1

ETSI EN 301 511 V12.5.1

EN 50665:2017

EN IEC 62311:2020

EN 62133-2:2017

EN IEC 63000:2018

Signed for and on behalf of: Willand (Beijing) Technology Co., LTD.

Place: Changzhou, China

Date: 22-02-2022

Name: Crystal Zhuang

Function: Certification Manager

Signature: *Crystal Zhuang*

**Manufacturer**

**Name:** Willand (Beijing) Technology Co., LTD.

**Address:** Room 203, A1 Bldg. Zhongguancun Dongsheng Technology Park (Northern Territory), No. 66, Xixiaokou Rd, Haidian Dist., Beijing, China.

**Authorized Representative**

**Name:** UKCA Experts Ltd.

**Address:** Dept 302, 43 Owston Road, Carcroft, Doncaster, DN6 8DA, United Kingdom

**Contact Person:** Ferry van Bergen Henegouw

**Function:** Certification Engineer

**Object of the declaration**

**Generic designation:** Robotic Lawnmower

**Product name:** Navimow

**Type/model:** H500E/H800E/H1500E/H3000E

**Serial number:** S2RA x yyyy x yyyy/S2RC x yyyy x yyyy/S2RE x yyyy x yyyy/S2RT x yyyy x yyyy

("x" indicates any letter from A-Z except O and I, "y" indicates any letter from A-Z except O and I or any number from 0-9)

**This Declaration of Conformity is issued under the sole responsibility of the manufacturer.**

The object of the declaration described above is in conformity with the following UK legislations:

1. Radio Equipment Regulations 2017
2. Supply of Machinery (Safety) Regulations 2008
3. The Restriction of the Use of Certain Hazardous Substances in Electrical and Electronic Equipment Regulations 2012

**Conformity with these Directives has been assessed for this product by demonstrating compliance to the following designated standards and/ or technical specifications:**

BS EN 60335-1:2012+A11:2014+AC:2014+A13:2017+A1:2019+A14:2019+A2:2019

BS EN 50636-2-107:2015+A1:2018+A2:2020

BS EN IEC 61000-3-2:2019+A1:2021

ETSI EN 301 908-1 V13.1.1

BS EN 61000-3-3:2013+A1:2019

ETSI EN 301 908-13 V13.1.1

BS EN IEC 55014-1:2021

ETSI EN 301 489-1 V2.2.3

BS EN IEC 55014-2:2021

ETSI EN 301 489 - 3 V2.2.0

ETSI EN 300 220-1 V3.1.1

ETSI EN 301 489-17 V3.2.4

ETSI EN 300 220-2 V3.1.1

ETSI EN 301 489-19 V2.1.1

ETSI EN 300 328 V2.2.2

ETSI EN 301 489-52 V1.2.1

ETSI EN 303 413 V1.1.1

ETSI EN 301 511 V12.5.1

BS EN 50665:2017

BS EN IEC 62311:2020

BS EN 62133-2:2017

BS EN IEC 63000:2018

**61**

Signed for and on behalf of: Willand (Beijing) Technology Co., LTD.

Place: Changzhou, China

Date: 22-02-2022

Name: Crystal Zhuang

Function: Certification Manager

Signature: *Crystal Zhuang*

# European Union Compliance Statement

## Information on Disposal for Users of Waste Electrical & Electronic Equipment



This symbol on the product or on its packaging indicates that used electrical and electronic products should not be mixed with unsorted municipal waste. For proper treatment, it is your responsibility to dispose of your waste equipment by arranging to return it to designated collection points.

Disposing of this product correctly will help save valuable resources and prevent any potential negative effects on human health and the environment, which could otherwise arise from inappropriate waste handling.

To return your used device, please use the return and collection systems or contact the retailer where the product was purchased, which is free of charge, please contact your local authority for further details of your nearest designated collection point.

Penalties may be applicable for incorrect disposal of this waste, in accordance with your national legislation.

## Information on Disposal for Users of used batteries



This symbol means that batteries and accumulators, at their end-of-life, should not be mixed with unsorted municipal waste. Your participation is an important part of the effort to minimize the impact of batteries and accumulators on the environment and on human health. For proper recycling you can return this product or the batteries or accumulators it contains to your supplier or to a designated collection point, which is free of charge.

Disposing of this product correctly will help save valuable resources and prevent any potential negative effects on human health and the environment, which could otherwise arise from inappropriate waste handling.

Penalties may be applicable for incorrect disposal of this waste, in accordance with your national legislation.

There are separate collection systems for used batteries and accumulators.

Please, dispose of batteries and accumulators correctly at your local community waste collection/recycling center.

## Restriction of the use of certain hazardous substances (RoHS) Directive

Willand (Beijing) Technology Co., LTD. hereby declares the whole product including parts (cables, cords, and so on) meets the requirements of RoHS Directive 2011/65/EU and amendment Commission Delegated Directive (EU) 2015/863 on the restriction of the use of certain hazardous substances in electrical and electronic equipment ("RoHS recast" or "RoHS 2.0").

## Radio Equipment Directive

Willand (Beijing) Technology Co., LTD. hereby declares that the product listed in this section comply with the essential requirements and other relevant provisions of the Radio Equipment Directive 2014/53/EU.

## Machinery Directive

Willand (Beijing) Technology Co., LTD. hereby declares that the product listed in this section comply with the essential requirements and other relevant provisions of the Machinery Directive 2006/42/EC.

## Europe Authorised Representative:



Segway Discovery B.V. Dynamostraat 7, 1014BN Amsterdam, The Netherlands.

Willand (Beijing) Technology Co., LTD. hereby declares that the product comply with the essential requirements and other relevant provisions of the RoHS Directive 2011/65/EU and amendment Commission Delegated Directive (EU) 2015/863, the Radio Equipment Directive 2014/53/EU and the Machinery Directive 2006/42/EC.

Bluetooth	Frequency Band(s)	2.4000-2.4835GHz
	Max. RF Power	20mW

# UK Compliance Statement

## Information on Disposal for Users of Waste Electrical & Electronic Equipment



This symbol on the product or on its packaging indicates that used electrical and electronic products should not be mixed with unsorted municipal waste. For proper treatment, it is your responsibility to dispose of your waste equipment by arranging to return it to designated collection points.

Disposing of this product correctly will help save valuable resources and prevent any potential negative effects on human health and the environment, which could otherwise arise from inappropriate waste handling.

To return your used device, please use the return and collection systems or contact the retailer where the product was purchased, which is free of charge, please contact your local authority for further details of your nearest designated collection point.

Penalties may be applicable for incorrect disposal of this waste, in accordance with your national legislation.

## Information on Disposal for Users of used batteries



This symbol means that batteries and accumulators, at their end-of-life, should not be mixed with unsorted municipal waste. Your participation is an important part of the effort to minimize the impact of batteries and accumulators on the environment and on human health. For proper recycling you can return this product or the batteries or accumulators it contains to your supplier or to a designated collection point, which is free of charge.

Disposing of this product correctly will help save valuable resources and prevent any potential negative effects on human health and the environment, which could otherwise arise from inappropriate waste handling.

Penalties may be applicable for incorrect disposal of this waste, in accordance with your national legislation.

There are separate collection systems for used batteries and accumulators.

Please, dispose of batteries and accumulators correctly at your local community waste collection/recycling center.

## The Restriction of the Use of Certain Hazardous Substances in Electrical and Electronic Equipment Regulations 2012

Willand (Beijing) Technology Co., LTD. hereby declares the whole product including parts (cables, cords, and so on) meets the requirements of The Restriction of the Use of Certain Hazardous Substances in Electrical and Electronic Equipment Regulations 2012.

## Radio Equipment Regulations 2017

Willand (Beijing) Technology Co., LTD. hereby declares that the product listed in this section comply with the essential requirements and other relevant provisions of Radio Equipment Regulations 2017.

## Supply of Machinery (Safety) Regulations 2008

Willand (Beijing) Technology Co., LTD. hereby declares that the product listed in this section comply with the essential requirements and other relevant provisions of The Safety of Supply of Machinery (Safety) Regulations 2008.

## UK Authorised Representative:



UKCA Experts Ltd. Dept 302, 43 Owston Road Carcroft, Doncaster, DN6 8DA, United Kingdom

Willand (Beijing) Technology Co., LTD. hereby declares that the product comply with the essential requirements and other relevant provisions of the Restriction of the Use of Certain Hazardous Substances in Electrical and Electronic Equipment Regulations 2012, the Radio Equipment Regulations 2017 and the Supply of Machinery (Safety) Regulations 2008.

Bluetooth	Frequency Band(s)	2.4000-2.4835GHz
	Max. RF Power	20mW

The declaration of conformity can be viewed at the following address: <https://navimow.segway.com/HelpCenter>



## Limited Warranty and Arbitration Agreement (EMEA)

NOTICE: PLEASE READ THIS LIMITED WARRANTY AND ARBITRATION AGREEMENT AND KEEP THIS AGREEMENT FOR FUTURE REFERENCE. THIS AGREEMENT CONTAINS LIMITED WARRANTY CLAUSES FOR CONSUMERS IN EUROPE, MIDDLE EAST AND AFRICA ("EMEA") AND ARBITRATION CLAUSES WITH RESPECT TO NAVIMOW ("PRODUCT") AND ANY AND ALL TRANSACTION AND CLAIM RELATED TO AND/OR ARISING OUT OF THE PRODUCT.

THIS IS A BINDING LEGAL AGREEMENT ("AGREEMENT") BETWEEN YOU (EITHER AN INDIVIDUAL OR ENTITY) AND THE MANUFACTURER ("WILLAND"), SEGWAY DISCOVERY B.V. EMEA ("SEGWAY"), AND THEIR AFFILIATES (INCLUDING BUT NOT LIMITED TO THEIR PARENT COMPANY, SUBSIDIARY, AFFILIATED COMPANIES, PREDECESSOR, SUBSEQUENT COMPANY, ADMINISTRATORS, SUCCESSORS, ASSIGNS, OFFICERS, DIRECTORS, MANAGERS, EMPLOYEES, MEMBERS, SHAREHOLDERS, AND AGENTS, ATTORNEYS, INSURERS OR REINSURERS) (COLLECTIVELY "SEGWAY PARTIES"), SEGWAY DEALERS (AS DEFINED BELOW) AND THEIR AFFILIATES (COLLECTIVELY "SEGWAY DEALERS").

PURCHASING THE PRODUCT, OPENING THE PRODUCT PACKAGING, USING THE PRODUCT, RETAINING THE PRODUCT, EXPLOITING THE BENEFITS OF THIS AGREEMENT, OR ELECTRONIC ACCEPTANCE OF THIS AGREEMENT SHALL CONSTITUTE ACCEPTANCE OF THIS AGREEMENT. IN AN EVENT YOU, AS A PARENT(S) OR LEGAL GUARDIAN(S), PURCHASE THIS PRODUCT ON BEHALF OF OR FOR YOUR CHILDREN, YOU HEREBY CONSENT TO AND APPROVE IN ALL RESPECTS THE TERMS AND CONDITIONS OF THE AGREEMENT AND AGREE THAT BOTH YOU AND YOUR CHILDREN SHALL BE BOUND BY THIS AGREEMENT. YOU ACKNOWLEDGE AND AGREE THAT YOU RECEIVE SUFFICIENT NOTICE OF THIS AGREEMENT AND YOU AGREE TO THIS AGREEMENT.

### Record your Product's Serial Number

Record your Product's Serial Number below. You can find the Serial Number on the exterior of the shipping box, or on the bottom of the Product.

Serial Number Here

### Contacts

The Product is manufactured by Willand (Beijing) Technology Co., LTD. ("Willand"), and distributed by Segway Discovery B.V. ("Segway").

#### 1. Limited Warranty

This Limited Warranty covers only defects of any material or quality of the Product and components when the Product and components thereof are being used under normal and ordinary conditions. In the event that a defect covered by this Limited Warranty occurs, Segway and/or other Segway Parties in its sole discretion will repair or replace the defective Product or components thereof in accordance with this Limited Warranty. The applicable Limited Warranty Period for the Limited Warranty commences on the date of the original purchase of the Product from either of Segway, Segway's authorized reseller, Segway's authorized distributor, or an authorized Dealer (each a "Segway Dealer" or collectively the "Segway Dealers").

Product covered by this warranty	Limited Warranty Period
H500E, H800E	3 years
H1500E, H3000E	4 years
Battery pack and power adaptors	2 years (H500E, H800E) 3 years (H1500E, H3000E)
Ultrasonic sensor	2 years
VisionFence sensor	2 years

Blades are seen as disposable and are not covered by this warranty.

THIS LIMITED WARRANTY HEREIN IS THE ONLY EXPRESS WARRANTY APPLICABLE TO PRODUCT AND ITS COMPONENT PARTS, ACCESSORIES, AND SERVICE REPAIR. SEGWAY AND SEGWAY PARTIES DISCLAIM ALL OTHER EXPRESS WARRANTIES. SEGWAY AND OTHER SEGWAY PARTIES LIMIT THE DURATION AND REMEDIES OF ALL IMPLIED WARRANTIES, INCLUDING WITHOUT LIMITATION TO THE WARRANTIES OF MERCHANTABILITY AND FITNESS FOR A PARTICULAR PURPOSE, WHETHER ARISING BY LAW, COURSE OF DEALING, COURSE OF PERFORMANCE, USAGE OF TRADE OR OTHERWISE, TO THE DURATION OF THIS EXPRESS LIMITED WARRANTY.

THIS LIMITED WARRANTY DESCRIBES THE SERVICE AVAILABLE TO YOU IN THE EVENT YOUR PRODUCT REQUIRES WARRANTY SERVICE. THIS LIMITED WARRANTY IS AN ADDITIONAL WARRANTY, THAT DOES NOT IN ANY WAY AFFECT OR LIMIT THE STATUTORY RIGHTS YOU MAY HAVE AS A CONSUMER, FOR EXAMPLE, WITH RESPECT TO CONFORMITY, AND YOU MAY HAVE ADDITIONAL PROTECTIONS UNDER YOUR LOCAL LAWS.

## 2. Limited Warranty Service Process

Segway's online services are available at [navimow.segway.com](http://navimow.segway.com). During your use of the Product, you believe the Product or its component is defective and/or does not work correctly. PLEASE IMMEDIATELY STOP USING THE PRODUCT, AND STORE THE PRODUCT PROPERLY. YOUR CONTINUED USE OF THE PRODUCT UNDER SUCH CIRCUMSTANCE MAY CAUSE SEVERE BODILY INJURY OR EVEN DEATH TO YOU OR THE OTHERS AND/OR CAUSE PROPERTY DAMAGES. Thereafter, please immediately contact Segway at [support-navimow@rlm.segway.com](mailto:support-navimow@rlm.segway.com). Segway's technical support personnel are available to assist you online or over the phone in diagnosing the defect, and if any, and providing further instructions. In the event the warranty services are required, please prepare for the following materials, including (i) proof of the original purchase of the Product from Segway Dealers, (ii) the Product's serial number, and (iii) a description of the defect if applicable. Upon the verification of your eligibility for the Limited Warranty protection and/or services, you should provide your name, email address, mailing address, and contact phone number to us, we will guide you to get our service.

If you want to return the defective unit to service, you shall be responsible for the cost of shipping and risk of loss and damage that may occur during the shipment from you to Segway and (ii) from Segway to you. You must include your defective Product or component within the original or Segway-approved packaging, which will be provided at your cost, for shipment of the Product to Segway. You shall defend, indemnify, and hold Segway harmless any loss and/or damages that may be caused by your improper packaging or shipment of the Product or component to Segway.

An authorized service provider or Segway Dealer will inspect your returned Product. If Segway reasonably determines that the problem is not covered by the Limited Warranty, Segway will notify you and inform you of service or replacement alternatives that are available to you on a fee basis, or Segway will return your Product to you unrepaired, and in such instance, you will be responsible for the cost of shipping and insurance for shipment of your Product from Segway to you. In an event that any services is not covered by the limited warranty and you reject a paid service recommended by Segway Parties and/or Segway Dealer, you understand and acknowledge that failure to repair and/or services the Product may increase the risk of fall and/or Product failure which may result in severe property damages, severe bodily injury or death, and you agree that this is your informed consent to take such risk.

For a return eligible for the warranty protection and/or services, Segway will serve defective Products with new or reconditioned parts of the same or similar style at no cost to you for the service. Parts replaced by Segway will be retained by and become the property of Segway. In such a situation, Segway will pay reasonable return shipping charges for the return of the Product to you.

## 3. Limited Warranty Eligibility

- 3.1 Your service request must be received by Segway within the Limited Warranty Period as described above, and Segway must receive your Product in accordance with the Limited Warranty Service Process defined above.
- 3.2 Your Product must be purchased from an authorized Segway Dealer.
- 3.3 You must provide the original purchase receipt.
- 3.4 Your Product must have serial number legible, unobscured, untampered, and unmodified.
- 3.5 All tamper-resistant seals must be intact, in place, and unmodified.

## 4. Limited Warranty Exclusions

This Limited Warranty describes the service available to you if your product requires warranty service, and you may have additional protections under your local laws. This Limited Warranty does not cover and excludes damage to your product or any component thereof caused by:

- 4.1 Abuse, misuse, recklessness, negligence, or commercial use.
- 4.2 Improper charging, storage, maintenance, or operation of the Product not in compliance with instructions or limitations as provided in the user materials.
- 4.3 Use of the Product not in compliance with applicable laws and regulations.
- 4.4 Use of the Product by persons with inadequate experience.
- 4.5 Accident, collision, fire damage, water damage, chemical damage, use of the product outside of the product's working temperature range, high-pressure water spray, earthquake, dropping.
- 4.6 Modifications to mechanical parts, modification of electronic parts, or modifications to software embedded in the Product.
- 4.7 Service, repair, and maintenance by unauthorized providers.
- 4.8 Cosmetic damages.
- 4.9 Use of the Product with third party product, component, or accessory.
- 4.10 The normal deterioration of wear and tear parts.
- 4.11 Use of the Product with overdue wear and tear parts.

## 5. LIABILITY DISCLAIMER AND LIMITATION

- 5.1 SEGWAY PARTIES DO NOT ASSUME OR AUTHORIZE ANYONE TO ASSUME ON ITS BEHALF, ANY OTHER OBLIGATION OR LIABILITY

IN CONNECTION WITH THE PRODUCT, ITS COMPONENT PARTS, ACCESSORIES, SERVICE REPAIR, OR THIS LIMITED WARRANTY.

5.2 SEGWAY PARTIES AND SEGWAY DEALERS ARE NOT RESPONSIBLE FOR ANY LOSS OF USE OF A PRODUCT, ITS COMPONENT PARTS, ACCESSORIES, OR FOR ANY INCONVENIENCE OR OTHER LOSS OR DAMAGE WHICH MIGHT BE CAUSED FROM ANY DEFECT IN A PRODUCT, ITS COMPONENT PARTS, ACCESSORIES, SERVICE REPAIR, OR FOR ANY OTHER INCIDENTAL OR CONSEQUENTIAL DAMAGES YOU MAY HAVE AS A RESULT OF ANY DEFECT IN A PRODUCT, ITS COMPONENT PARTS, ACCESSORIES, OR SERVICE REPAIR. SOME COUNTRIES DO NOT ALLOW THE EXCLUSION OR LIMITATION OF INCIDENTAL OR CONSEQUENTIAL DAMAGES, SO THE ABOVE LIMITATION OR EXCLUSION MAY NOT APPLY TO YOU TO THE EXTENT THAT IT IS DISALLOWED BY APPLICABLE LAW.

5.3 IN NO EVENT, SEGWAY PARTIES AND SEGWAY DEALERS' TOTAL AND AGGREGATE LIABILITY FOR ALL CLAIMS UNDER ANY AND ALL APPLICABLE LAW OR THEORY, JOINTLY OR SEVERALLY, ARISING OUT OF OR RELATED TO THE PURCHASE OF THE PRODUCT, USE OF THE PRODUCT, BREACH OF CONTRACT, TORTS (INCLUDING NEGLIGENCE) OR OTHERWISE, EXCEEDS THE DUTY TO REPAIR OR REPLACE ANY DEFECTIVE PRODUCT, FURTHER SUBJECT TO SEGWAY'S SOLE AND EXCLUSIVE DISCRETION. IN NO EVENT SHALL BE SEGWAY PARTIES AND SEGWAY DEALERS BE LIABLE TO ANY PERSON FOR CONSEQUENTIAL, INDIRECT, INCIDENTAL, SPECIAL, EXEMPLARY, PUNITIVE OR ENHANCED DAMAGES ARISING OUT OF, OR RELATING TO, AND/OR IN CONNECTION WITH THE PURCHASE OF THE PRODUCT, ANY BREACH OF THIS AGREEMENT OR MANUFACTURER'S DUTIES REGARDLESS OF (A) WHETHER SUCH DAMAGES WERE FORESEEABLE, (B) WHETHER OR NOT SEGWAY OR OTHER SEGWAY PARTIES WERE ADVISED OF THE POSSIBILITY OF SUCH DAMAGES, AND (C) THE LEGAL OR EQUITABLE THEORY (CONTRACT, TORT OR OTHERWISE) UPON WHICH THE CLAIM IS BASED UNLESS SUCH LIMITATIONS AND EXCLUSIONS ARE PROHIBITED BY APPLICABLE LAW. THE FOREGOING LIMITATIONS OR EXCLUSIONS APPLY EVEN IF AN AGGRIEVED CUSTOMER OR ANY OTHER PERSON'S (WHO MIGHT HAVE RIGHT OR CLAIM UNDER THIS AGREEMENT BY OPERATION OF LAW OR EQUITY) REMEDIES UNDER THIS AGREEMENT FAIL THEIR ESSENTIAL PURPOSE. IN THE EVENT SOME COUNTRIES DO NOT ALLOW THE EXCLUSION OR LIMITATION OF CERTAIN OR ALL OF THE FOREGOING DAMAGES, SO TO THE EXTENT THAT SUCH LIMITATIONS OR EXCLUSIONS ARE NOT ALLOWED BY LAW, THEY MAY NOT APPLY TO YOU. SOME COUNTRIES DO NOT ALLOW THE EXCLUSION OR LIMITATION OF INCIDENTAL OR CONSEQUENTIAL DAMAGES, SO TO THE EXTENT THAT SUCH LIMITATIONS OR EXCLUSIONS ARE NOT ALLOWED BY LAW, THE ABOVE LIMITATION OR EXCLUSION MAY NOT APPLY TO YOU.

5.4 To the extent permitted by applicable law, SEGWAY PARTIES and SEGWAY DEALERS hereby DISCLAIM any liability and thereby shall not be responsible for any damages, including but not limited to death, bodily injury, or damages to property, arising out of or related to any conduct (including misconduct), action, inaction, act (including failure to act), omission or negligence by any authorized or unauthorized dealer, distributor, wholesaler, retailer, service provider or third party that involves into the distribution of Product or the services thereto. To the extent permitted by applicable law, the explicit representations and warranties, if any, provided herein, shall be the only warranties and representations made by SEGWAY PARTIES to YOU, any consumer, and/or end-user. and SEGWAY PARTIES shall not be responsible for any other warranties and/or representations that may be given and/or provided by another person unless SEGWAY PARTIES have in a written form explicitly authorized such additional warranty and/or representation to be given to consumer or end-user.

## **6. Claims, Dispute Resolution and Arbitration**

THE CLAUSES CONTAINED HEREIN ARE LEGALLY BINDING BETWEEN YOU (EITHER AN INDIVIDUAL OR ENTITY), AND SEGWAY DISCOVERY B.V., ITS AFFILIATES, SEGWAY PARTIES AND SEGWAY DEALERS. THE CLAUSES CONTAINED HEREIN MAY AFFECT YOUR RIGHTS, AND IT IS YOUR RESPONSIBILITY TO READ THE FOLLOWING SECTIONS. YOU CAN OPT OUT OF THE AGREEMENT WITHIN 30 CALENDAR DAYS OF THE FIRST CONSUMER PURCHASE BY EMAILING OPTOUT@SEGWAY.COM AND PROVIDING THE APPLICABLE INFORMATION. FOR MORE DETAILS, PLEASE SEE SECTION 6.2.

### **6.1 Binding Arbitration**

Segway Parties, Segway Dealers and you agree that any dispute, controversy or claim arising out of, relating to or in connection with this agreement, the limited warranty, the sale, condition or performance of the product, whether based in contract, tort, fraud, misrepresentation, or any other legal theory at law or in equity, including but not limited to any claims for death, injury or property damages, shall be governed by and construed in accordance with the laws of the Netherlands with the exclusion of its conflicts of law provisions, and finally resolved by the International Chamber of Commerce (ICC) under the 2021 ICC Rules of Arbitration (ICC Rules) for the time being in force, which Rules are deemed to be incorporated by reference into this clause. Further the Parties agree that:

- i. The seat of the arbitration shall be Amsterdam, Netherlands.
- ii. The Tribunal shall consist of 3 arbitrator(s).
- iii. The language of the arbitration shall be English.

Section 6 "Claims, Dispute Resolution and Mandatory Arbitration" clause shall survive upon termination or expiration of this agreement and/or limited warranty or in an event that this agreement and/or the limited warranty is held as void, avoidable, invalid, or unenforceable, either in whole or part, by a competent adjudication institution with actual authority and jurisdiction

over this matter.

## 6.2 Opt-Out

YOU MAY OPT OUT OF THIS DISPUTE RESOLUTION PROCEDURE BY PROVIDING NOTICE TO SEGWAY or SEGWAY PARTIES NO LATER THAN THIRTY (30) CALENDAR DAYS AFTER THE DATE OF THE FIRST CONSUMER PURCHASER'S PURCHASE OF THE PRODUCT. TO OPT-OUT, YOU MUST SEND NOTICE BY EMAIL AT OPTOUT@SEGWAY.COM, WITH THE SUBJECT LINE: "ARBITRATION OPT-OUT." THE OPT-OUT NOTICE BY E-MAIL MUST INCLUDE (A) YOUR NAME, EMAIL ADDRESS, MAILING ADDRESS, AND PHONE NUMBER; (B) THE DATE ON WHICH THE PRODUCT WAS PURCHASED; (C) THE PRODUCT MODEL NAME OR MODEL NUMBER; AND (D) THE SERIAL NUMBER. ALTERNATIVELY, YOU MAY OPT OUT BY SENDING AN ELECTION TO OPT-OUT LETTER TO SEGWAY AT Dynamostraat 7, 1014BN Amsterdam, The Netherlands. CERTIFIED MAIL WITHIN THIRTY (30) CALENDAR DAYS FROM THE DATE OF THE FIRST END USER'S PURCHASE OF THE PRODUCT FROM SEGWAY DEALER. THE OPT-OUT LETTER SHALL CONTAIN THE FOLLOWING INFORMATION: (A) YOUR NAME, EMAIL ADDRESS, MAILING ADDRESS, AND PHONE NUMBER; (B) THE DATE ON WHICH THE PRODUCT WAS PURCHASED; (C) THE PRODUCT MODEL NAME OR MODEL NUMBER; (D) THE SERIAL NUMBER; AND (E) AN STATEMENT AS FOLLOWS: THE ABOVE CONSUMER ELECTS TO OPT-OUT THE DISPUTE RESOLUTION PROCEDURE AS PROVIDED BY THIS LIMITED WARRANTY, THESE ARE THE ONLY TWO EFFECTIVE WAYS TO OPT-OUT THIS DISPUTE RESOLUTION PROCEDURE. ELECTION TO OPT-OUT THIS DISPUTE RESOLUTION PROCEDURE WILL NOT AFFECT THE COVERAGE OF THE LIMITED WARRANTY IN ANY WAY, AND YOU WILL CONTINUE TO ENJOY THE BENEFITS OF THE LIMITED WARRANTY.

## 6.3 Language

This Agreement may be translated into different languages. In the event of a conflict, the English version shall prevail and control.

Please update the Navimow app for the latest version to get the latest User Manual.

The content entry can be found in the app via Settings>APP>Service and Help.

The functions and contents mentioned in this manual are related to the product model you purchase, the markets and the software version. Refer to the release note for the latest feature updates.

**Manufacturer:** Willand (Beijing) Technology Co., LTD.

**Address:** Room 203, A1 Bldg. Zhongguancun Dongsheng Technology Park (Northern Territory), No. 66, Xixiaokou Rd, Haidian Dist., Beijing, China.

**Contact us if you experience issues relating to the operation, maintenance and safety, or errors/faults with your mower.**

**Europe Authorised representative:** Segway Discovery B.V., Dynamostraat 7, 1014BN Amsterdam, The Netherlands.

**UK Authorised Representative:** UKCA Experts Ltd., Dept 302, 43 Owston Road, Carcroft, Doncaster, DN6 8DA, United Kingdom

**Website:** [navimow.segway.com](http://navimow.segway.com)

**E-mail Sales:** [navimow@rlm.segway.com](mailto:navimow@rlm.segway.com)

**E-mail Service:** [support-navimow@rlm.segway.com](mailto:support-navimow@rlm.segway.com)

The manufacturer reserves the right to make changes to the product, release firmware updates, and update this manual at any time. Illustrations of the product, accessories, and app interface in the User Manual are for reference purposes only. Actual product and functions may vary. Go to [navimow.segway.com](http://navimow.segway.com) for the latest user materials.